

9 8 7 6 5 4 3 2 1

G F E D C B A

A B C D E F G

9 8 7 6 5 4 3 2 1

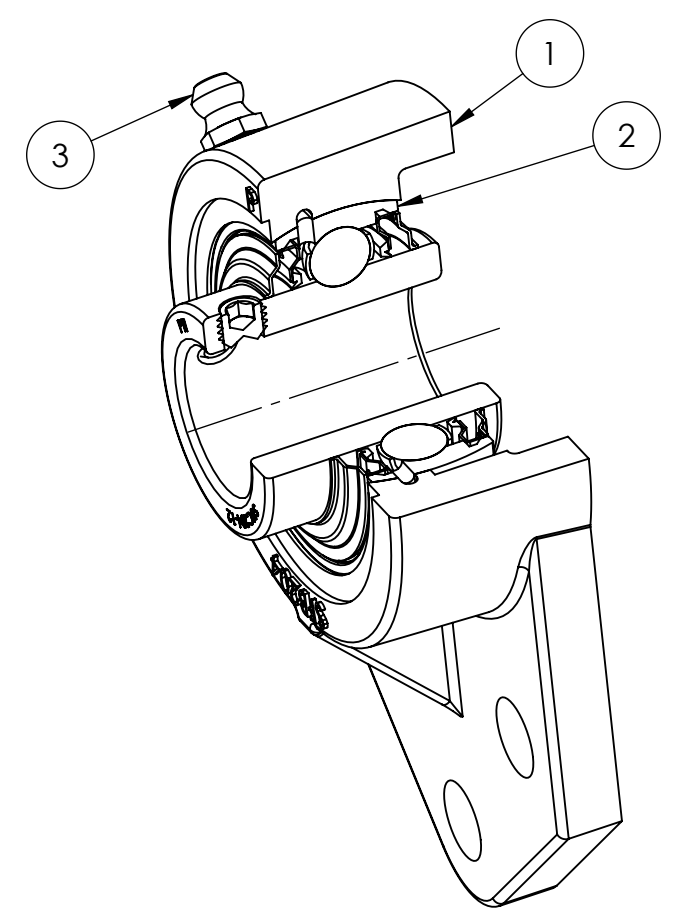
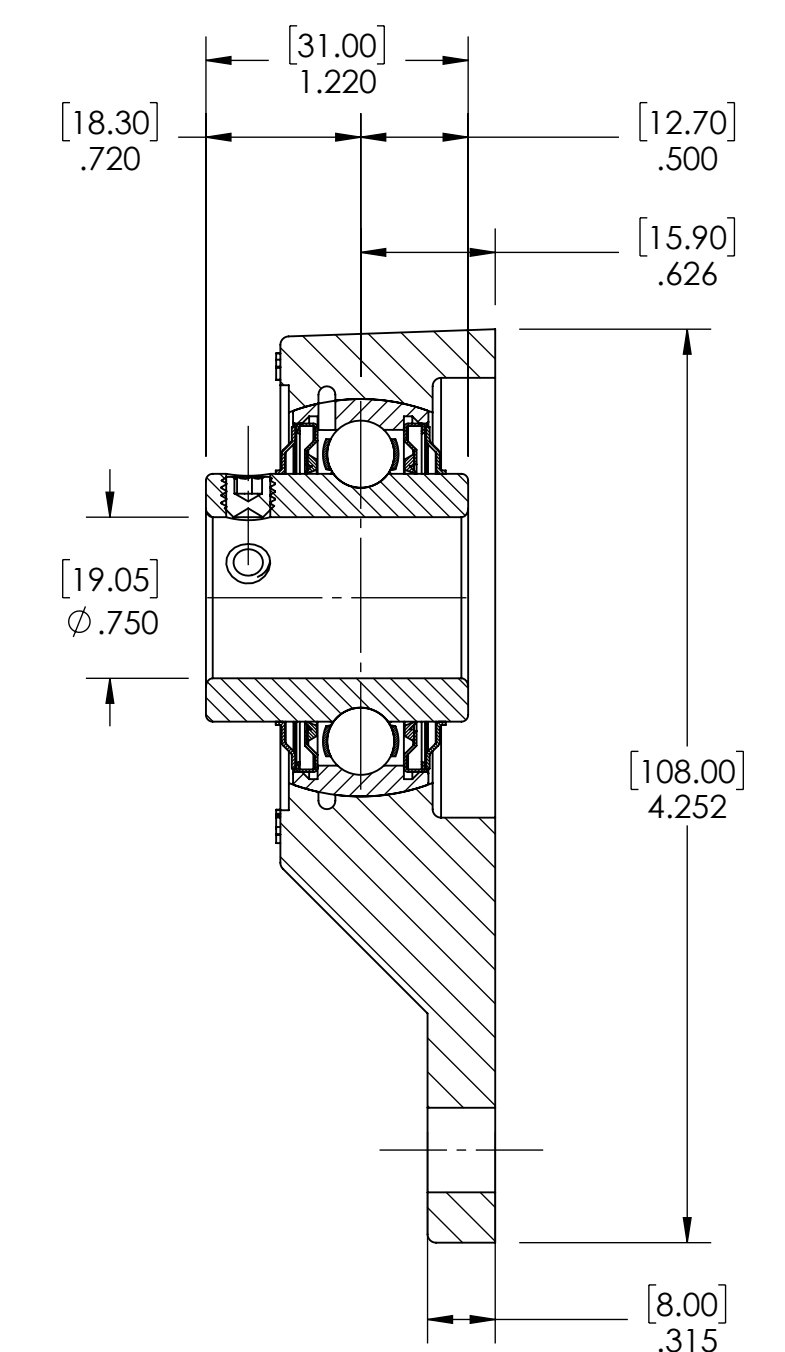
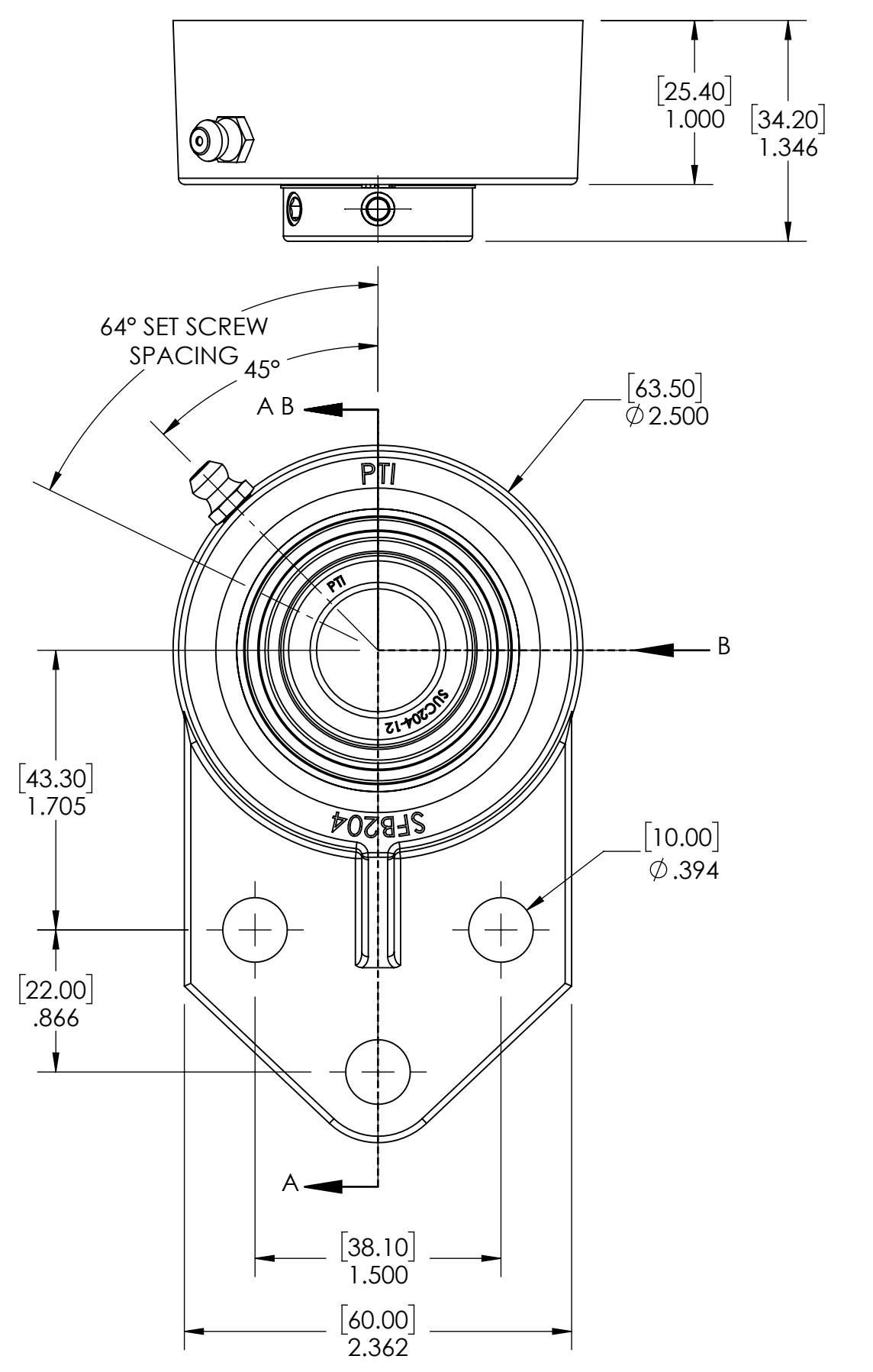

SECTION VIEW A-A

SPECIFICATIONS		WEIGHT	
UNITS:	IN (mm)		1.19 LBS
LOAD RATINGS	C: 2,400 LBS Co: 1,180 LBS	MATERIAL	SEE BOM
		COATING	SEE BOM
SPEED RATING	7450 RPM	DRAWN	SEC 01/07/2025
GREASE TYPE	FM222	CHECKED	SEC 01/08/2025
GREASE FILL	40%	APPROVED	
OPERATING TEMP	-10°F - 250°F	THIRD ANGLE PROJECTION	
SEAL TYPE	K-TYPE		
INTERNAL CLEARANCE	C3		
TORQUE SETTING ON SET SCREWS			

ITEM NO.	PART NUMBER	MATERIAL	COATING	QTY.
3	M6 ZERK	STAINLESS STEEL	N/A	1
2	SUC204-12	STAINLESS STEEL	N/A	1
1	SFB204	STAINLESS STEEL	N/A	1

DATE	BY	REVISION DESCRIPTION	REV
ITEM DESCRIPTION:			SCALE
SUCSFB204-12			1:13
			REV
			-



PROPRIETARY AND CONFIDENTIAL
THE INFORMATION CONTAINED IN THIS DRAWING IS THE SOLE PROPERTY OF SOLVE IMG. ANY REPRODUCTION IN PART OR AS A WHOLE WITHOUT THE WRITTEN PERMISSION OF SOLVE IMG IS PROHIBITED.