

9 8 7 6 5 4 3 2 1

G
F
E
D
C
B
A

G
F
E
D
C
B
A

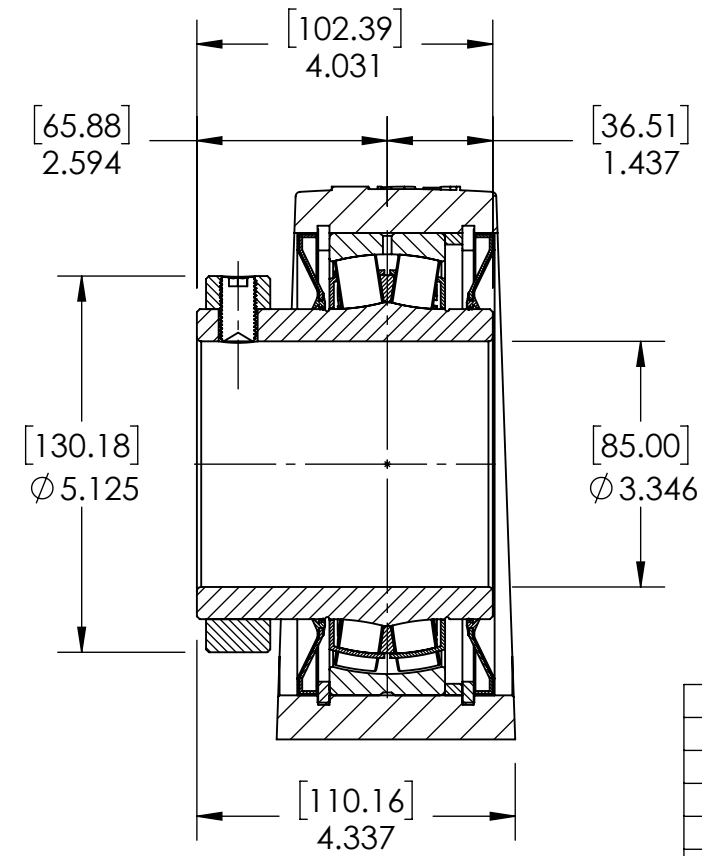
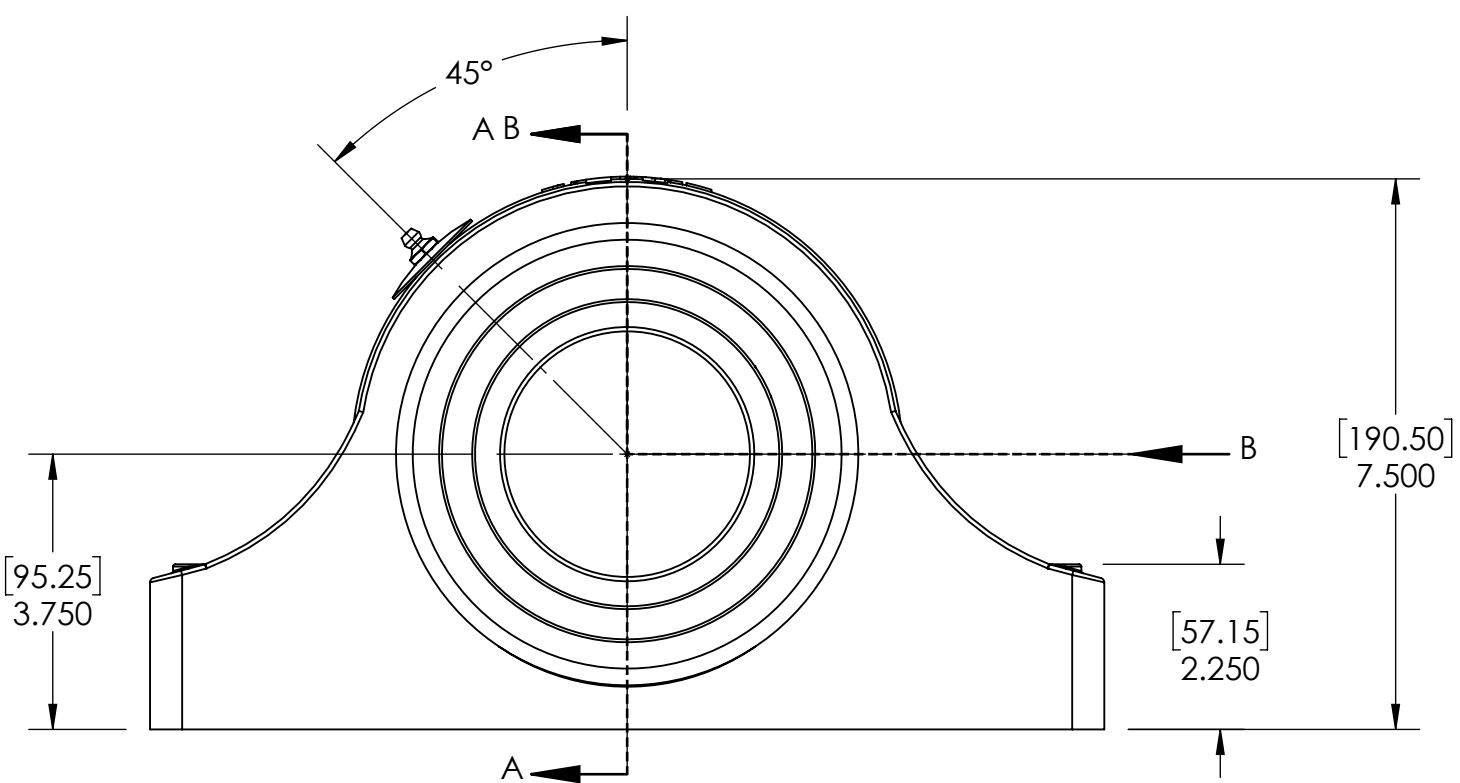
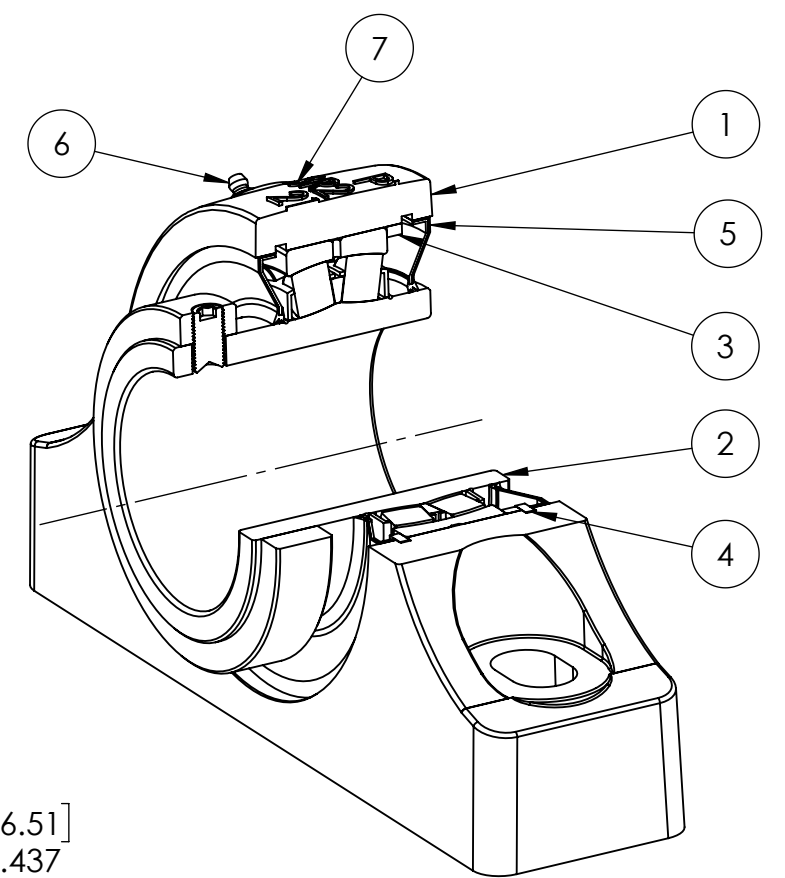
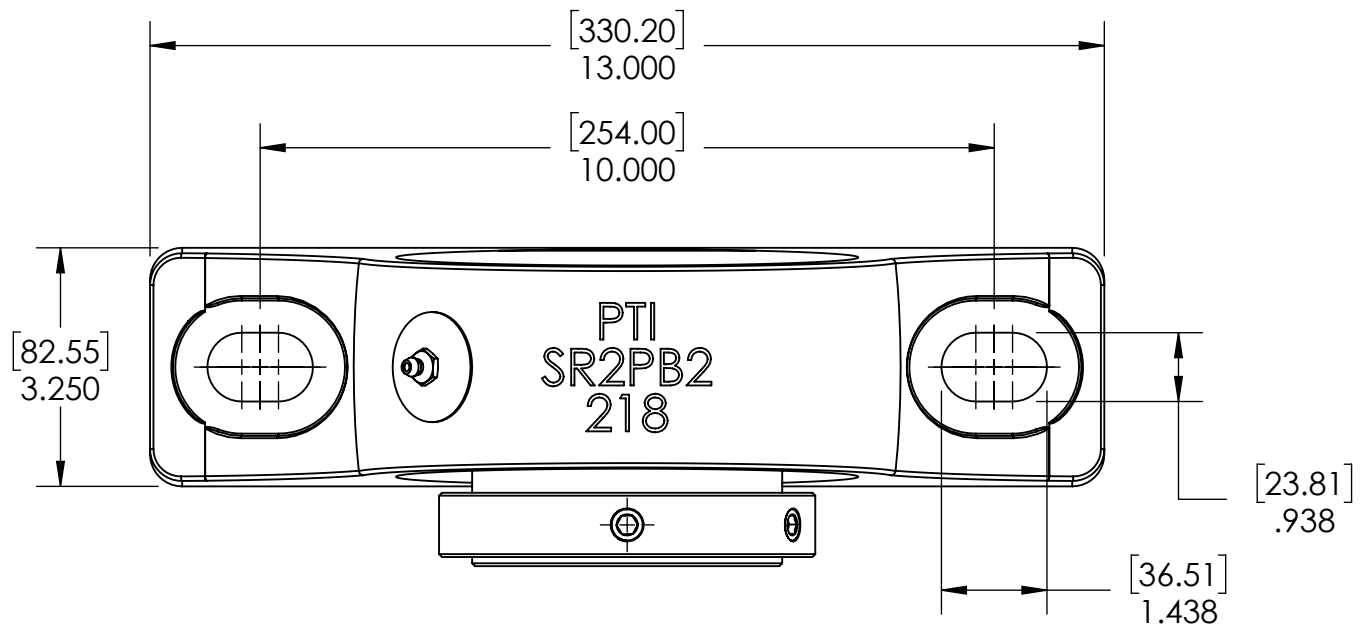

SECTION VIEW A-A

ITEM NO.	PART NUMBER	MATERIAL	COATING	QTY.
7	NP-SR2-NE	STEEL	N/A	1
6	1_8-27 ZERK	STEEL	ZINC PLATED	1
5	R3-476218	HNBR	N/A	2
4	OH160	STEEL	N/A	2
3	SR-FR160X6	STEEL	N/A	1
2	476218-85MM	BEARING STEEL	N/A	1
1	SR2PB2-218	DUCTILE IRON	POWDER COAT	1

SPECIFICATIONS	
UNITS	IN [mm]
LOAD RATINGS	C 62950 LBS Co 83180 LBS
SPEED RATING	1250 RPM
GREASE TYPE	NLGI #2
GREASE FILL	40-60%
OPERATING TEMP	-22°F - 290°F
SET SCREW SIZE	1/2-20UNF-7/8
SET SCREW TORQUE	620 IN-LBS
SET SCREW AXIAL RETENTION	900 LBS

SOLVE INDUSTRIAL MOTION GROUP
PTI
DWG. NO.

WEIGHT	38.10 LBS
MATERIAL	SEE BOM
COATING	SEE BOM
DRAWN	SEC 03/12/2025
CHECKED	FP 04/15/2025
APPROVED	
THIRD ANGLE PROJECTION	
PROPRIETARY AND CONFIDENTIAL	THE INFORMATION CONTAINED IN THIS DRAWING IS THE SOLE PROPERTY OF SOLVE IMG. ANY REPRODUCTION IN PART OR AS A WHOLE WITHOUT THE WRITTEN PERMISSION OF SOLVE IMG IS PROHIBITED.

DATE	BY	REVISION DESCRIPTION	REV
ITEM DESCRIPTION: SR2-PB2-85MMR3NE			SCALE 1:8
			REV -

9 8 7 6 5 4 3 2 1