

9 8 7 6 5 4 3 2 1

G
F
E
D
C
B
A

G
F
E
D
C
B
A

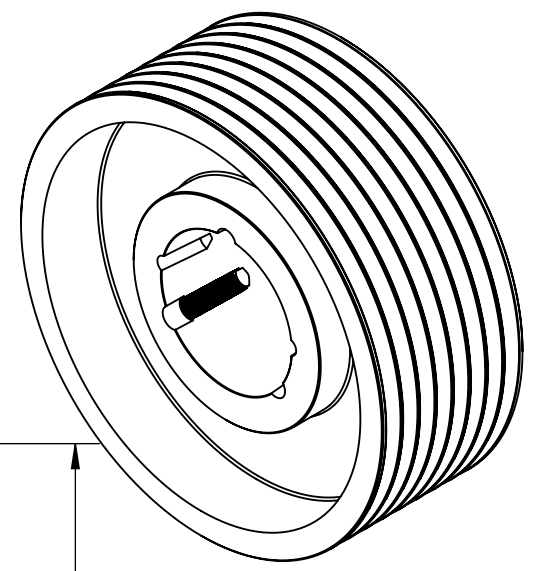
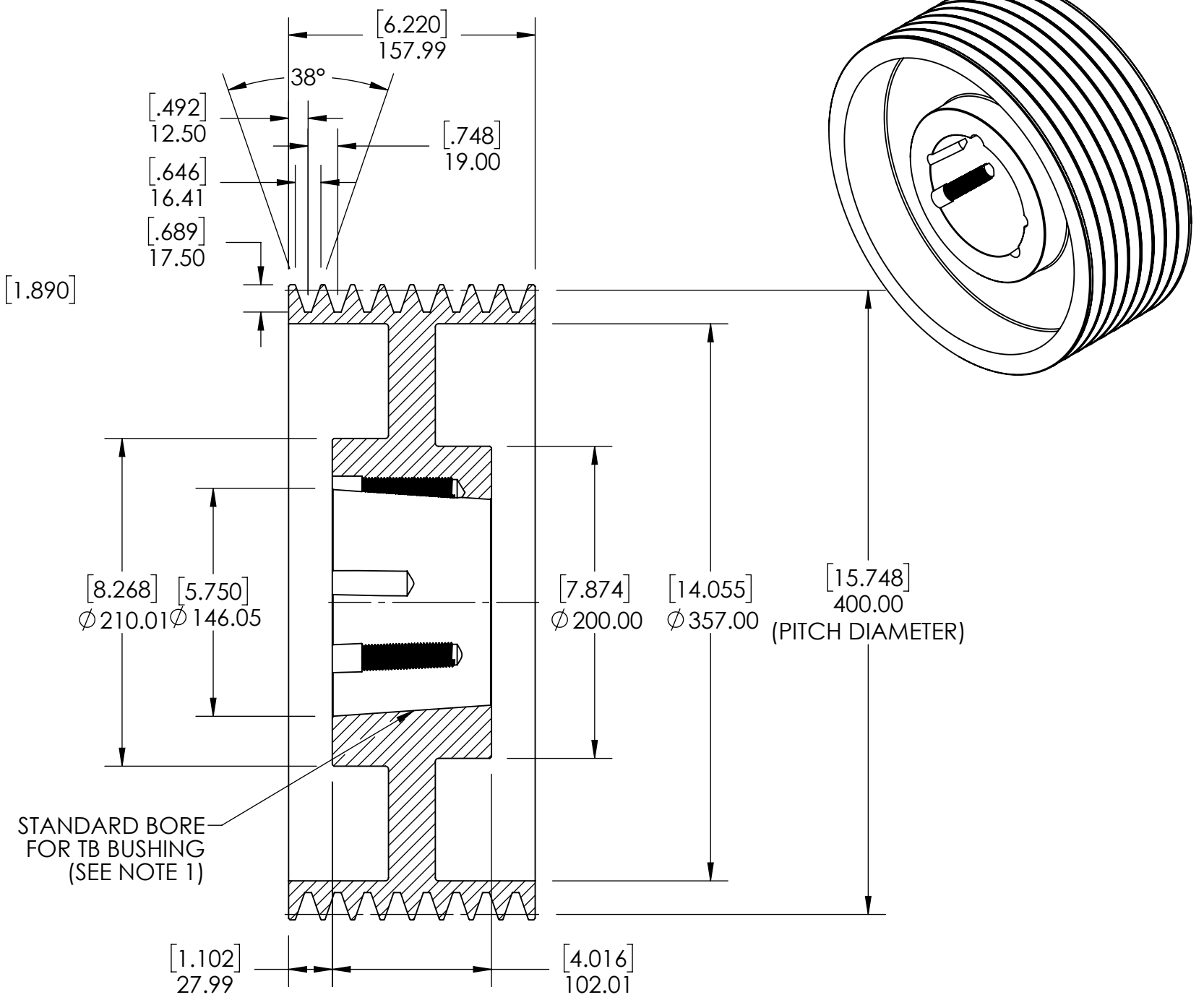
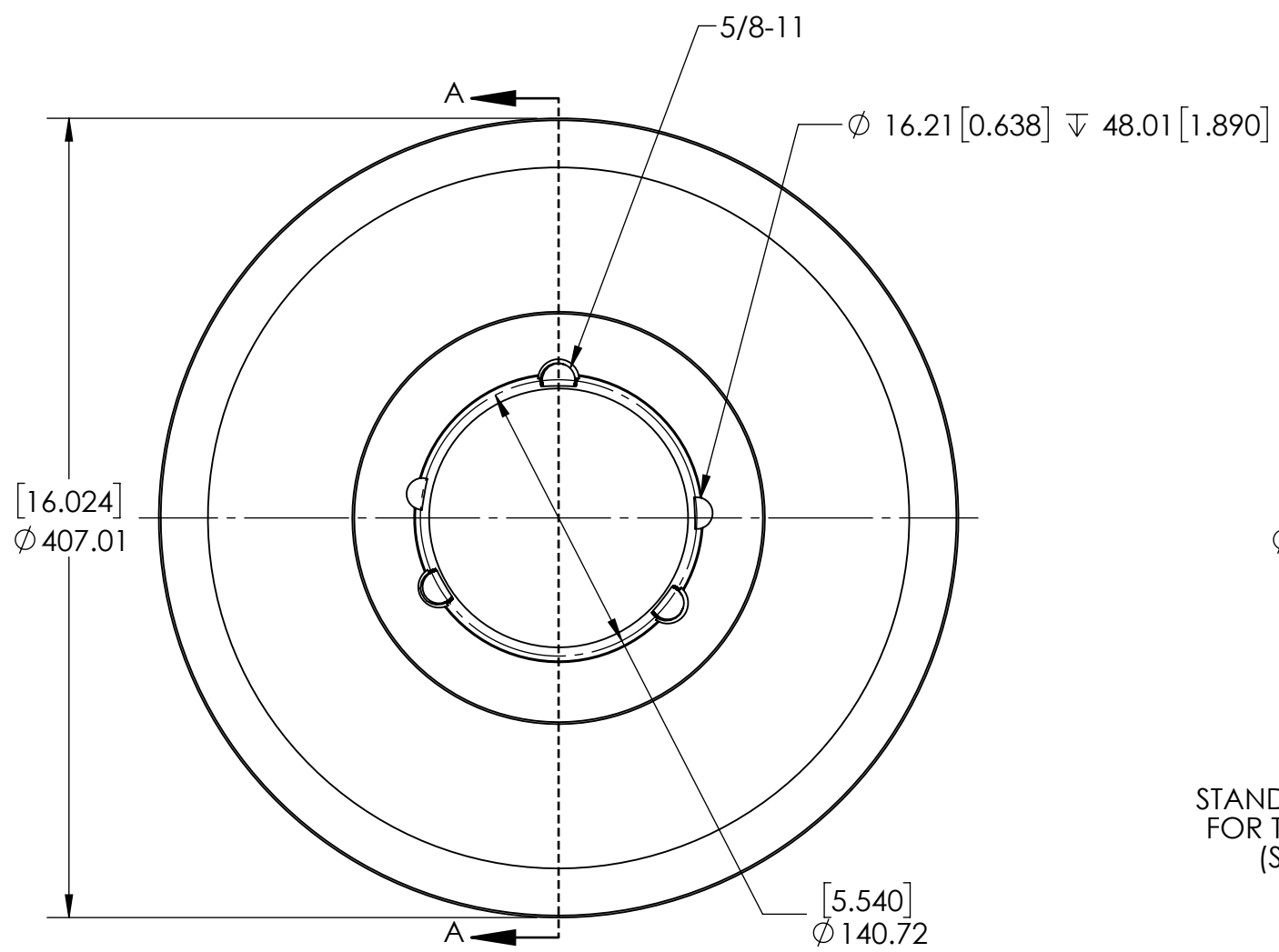

SECTION A-A

NOTES:
1. TB BUSHING SIZE: 4040
2. UNITS: mm [INCHES].

SOLVE INDUSTRIAL MOTION GROUP		WEIGHT	48.51 KG				
		MATERIAL	CAST IRON				
		COATING	GREY PAINT				
		DRAWN	MTC	09/02/2025			
		CHECKED					
		APPROVED			DATE	BY	REVISION DESCRIPTION
SIZE	PTI	THIRD ANGLE PROJECTION		ITEM DESCRIPTION:			REV
DWG. NO.	PROPRIETARY AND CONFIDENTIAL	THE INFORMATION CONTAINED IN THIS DRAWING IS THE SOLE PROPERTY OF SOLVE IMG. ANY REPRODUCTION IN PART OR AS A WHOLE WITHOUT THE WRITTEN PERMISSION OF SOLVE IMG IS PROHIBITED.		SPB400X8-4040			SCALE
							1:3.5
							REV
							-

9 8 7 6 5 4 3 2 1