

2

1

B

B

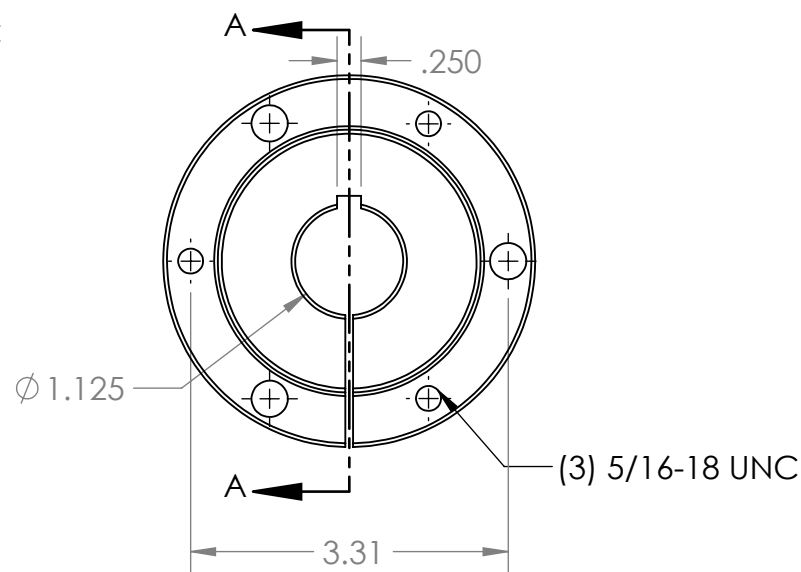
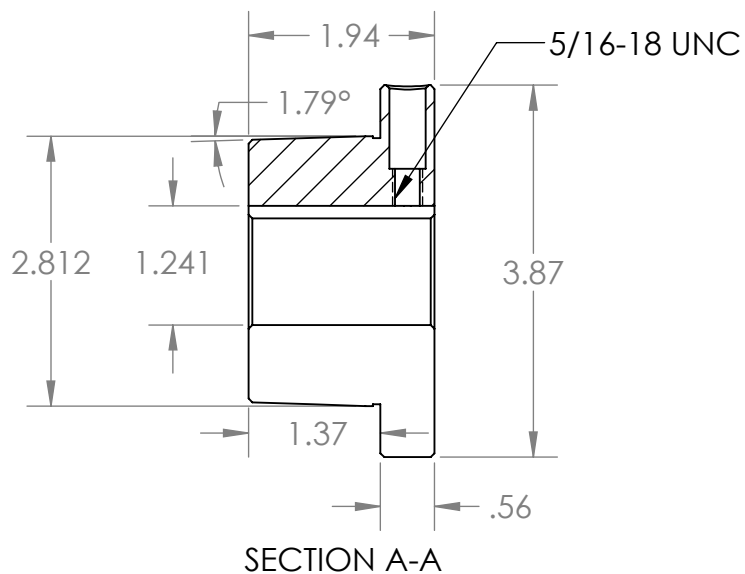
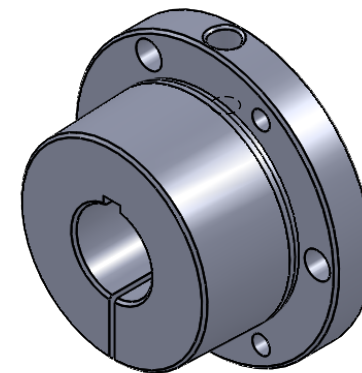

A

A

PROPRIETARY AND CONFIDENTIAL
 THE INFORMATION CONTAINED IN THIS DRAWING IS THE SOLE PROPERTY OF MASTERDRIVE, INC. ANY REPRODUCTION IN PART OR AS A WHOLE WITHOUT THE WRITTEN PERMISSION OF MASTERDRIVE, INC. IS PROHIBITED.

			INTERPRET GEOMETRIC TOLERANCING PER:
			MATERIAL QT450-10 (Ductile Iron)
			FINISH Black Phosphate
NEXT ASSY	USED ON		
APPLICATION		DO NOT SCALE DRAWING	

	NAME	DATE
DRAWN	EDG	07/21/20
CHECKED		
ENG APPR.		
MFG APPR.		
Q.A.		
COMMENTS:		



TITLE: SK1.1/8		
SIZE A	DWG. NO. SK1.125	REV
SCALE: 1:2	WEIGHT:	SHEET 1 OF 1

2

1