

2

1

B

B

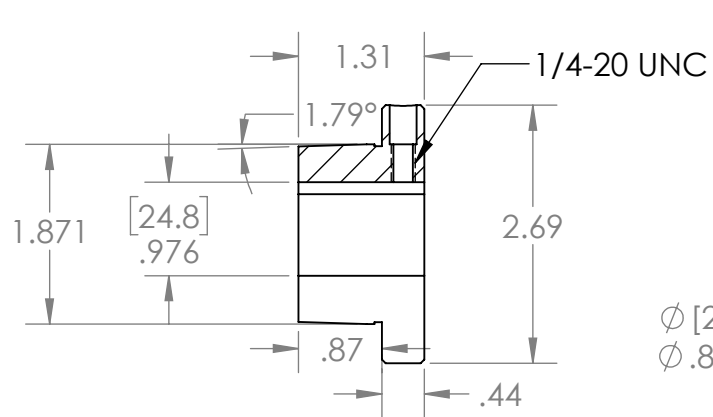
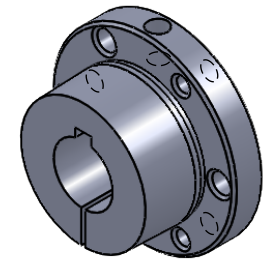

SECTION A-A

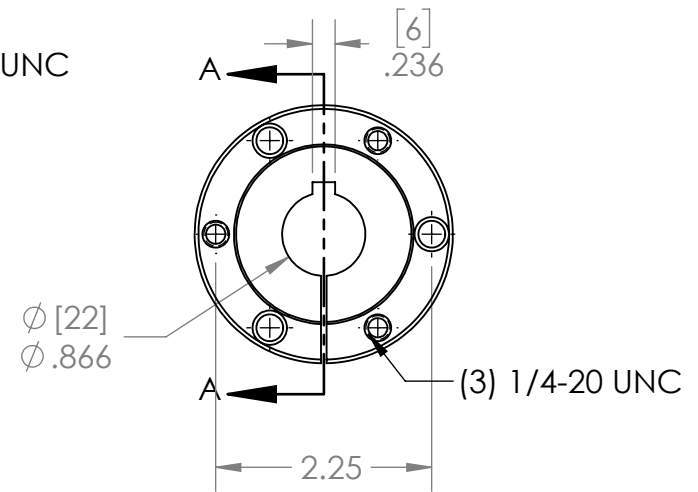

A

A

PROPRIETARY AND CONFIDENTIAL
 THE INFORMATION CONTAINED IN THIS DRAWING IS THE SOLE PROPERTY OF MASTERDRIVE, INC. ANY REPRODUCTION IN PART OR AS A WHOLE WITHOUT THE WRITTEN PERMISSION OF MASTERDRIVE, INC. IS PROHIBITED.

				NAME	DATE
			DRAWN	EDG	08/18/20
			CHECKED		
			ENG APPR.		
			MFG APPR.		
			Q.A.		
			COMMENTS:		
		INTERPRET GEOMETRIC TOLERANCING PER:			
		MATERIAL	QT450-10 (Ductile Iron)		
		FINISH	Black Phosphate		
NEXT ASSY	USED ON				
APPLICATION		DO NOT SCALE DRAWING			



TITLE: **SH22MM**

SIZE **A** DWG. NO. **SH22MM** REV

SCALE: 1:2 WEIGHT: SHEET 1 OF 1

2

1