

2

1

B

B

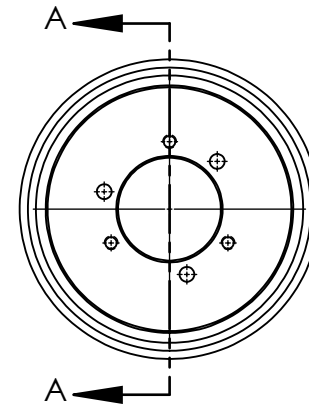
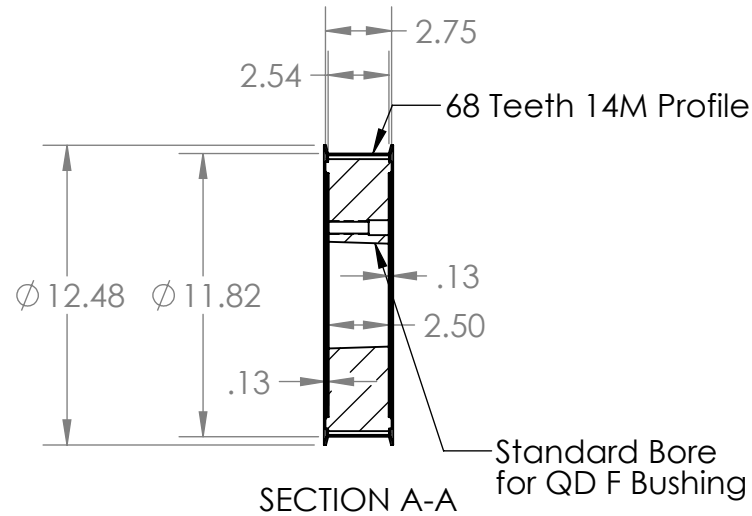
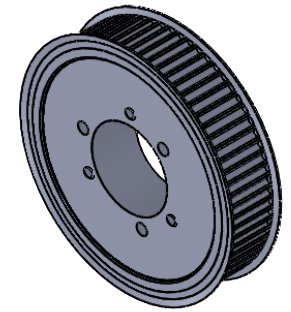

A

A

PROPRIETARY AND CONFIDENTIAL
 THE INFORMATION CONTAINED IN THIS DRAWING IS THE SOLE PROPERTY OF MASTERDRIVE, INC. ANY REPRODUCTION IN PART OR AS A WHOLE WITHOUT THE WRITTEN PERMISSION OF MASTERDRIVE, INC. IS PROHIBITED.

				NAME	DATE
				DRAWN	EDG 12/29/21
				CHECKED	
				ENG APPR.	
				MFG APPR.	
				Q.A.	
				COMMENTS:	
		INTERPRET GEOMETRIC TOLERANCING PER:			
		MATERIAL	HT200 (Cast Iron)		
		FINISH	Grey Paint		
NEXT ASSY	USED ON				
APPLICATION		DO NOT SCALE DRAWING			



TITLE:
P68-14M-55-F

SIZE	DWG. NO.	REV
A	P68-14M-55-F	
SCALE: 1:8	WEIGHT:	SHEET 1 OF 1

2

1