

2

1

B

B

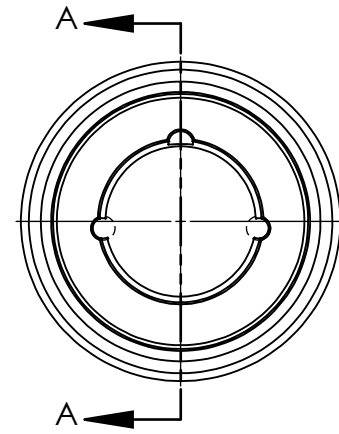
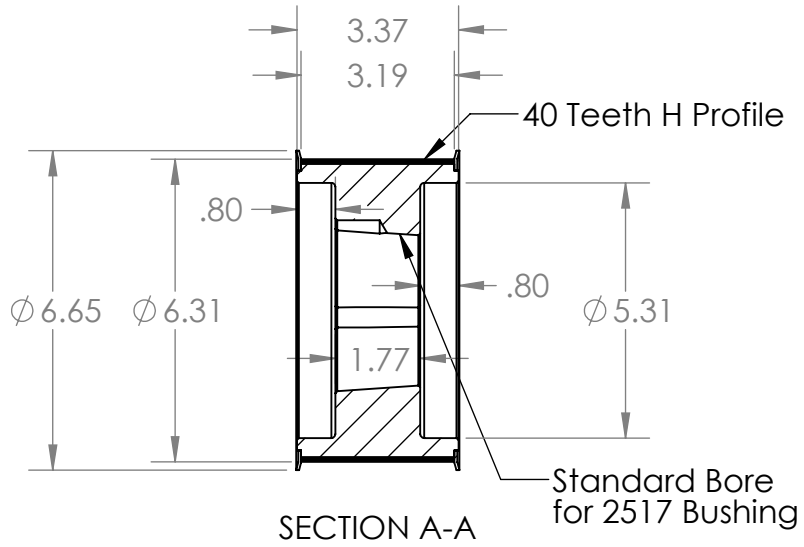
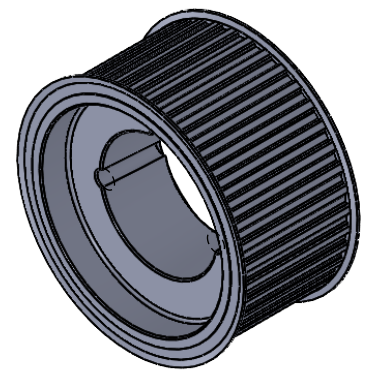

A

A

PROPRIETARY AND CONFIDENTIAL
 THE INFORMATION CONTAINED IN THIS DRAWING IS THE SOLE PROPERTY OF MASTERDRIVE, INC. ANY REPRODUCTION IN PART OR AS A WHOLE WITHOUT THE WRITTEN PERMISSION OF MASTERDRIVE, INC. IS PROHIBITED.

				NAME	DATE
				DRAWN	EDG 11/08/21
				CHECKED	
				ENG APPR.	
				MFG APPR.	
				Q.A.	
				COMMENTS:	
			INTERPRET GEOMETRIC TOLERANCING PER:		
			MATERIAL		
			HT200 (Cast Iron)		
			FINISH		
			Grey Paint		
NEXT ASSY	USED ON				
APPLICATION			DO NOT SCALE DRAWING		



TITLE:
P40H300-2517

SIZE	DWG. NO.	REV
A	P40H300-2517	
SCALE: 1:4	WEIGHT:	SHEET 1 OF 1

2

1