

2

1

B

B

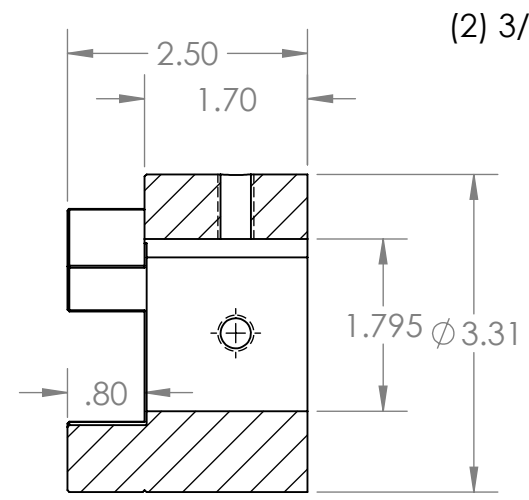
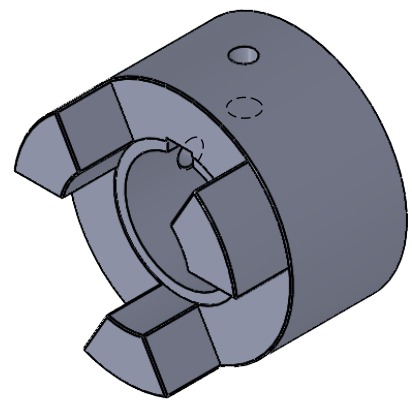

SECTION A-A

(2) 3/8-16 UNC

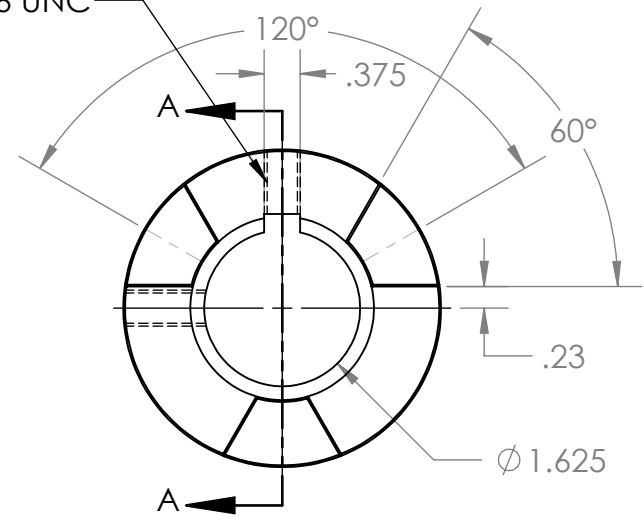

A

A

PROPRIETARY AND CONFIDENTIAL
 THE INFORMATION CONTAINED IN THIS DRAWING IS THE SOLE PROPERTY OF MASTERDRIVE INC. ANY REPRODUCTION IN PART OR AS A WHOLE WITHOUT THE WRITTEN PERMISSION OF MASTERDRIVE INC IS PROHIBITED.

				NAME	DATE
			DRAWN	EDG	02/07/22
			CHECKED		
			ENG APPR.		
			MFG APPR.		
			Q.A.		
			COMMENTS:		
		INTERPRET GEOMETRIC TOLERANCING PER:			
		MATERIAL	HT200 (Cast Iron)		
		FINISH	Black Phosphate		
NEXT ASSY	USED ON				
APPLICATION		DO NOT SCALE DRAWING			



TITLE:		
L110-1-5/8		
SIZE	DWG. NO.	REV
A	L110-1.625	
SCALE: 1:2	WEIGHT:	SHEET 1 OF 1

2

1