

2

1

B

B

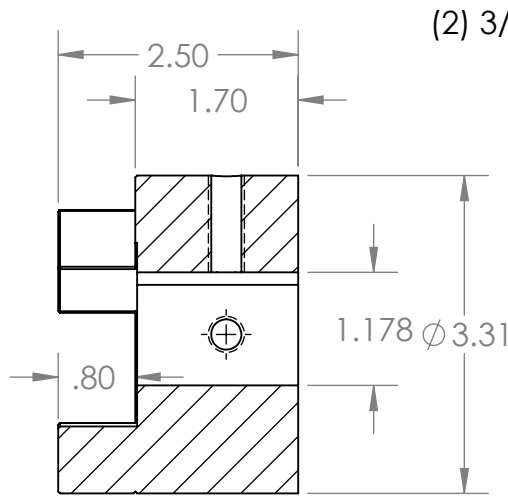
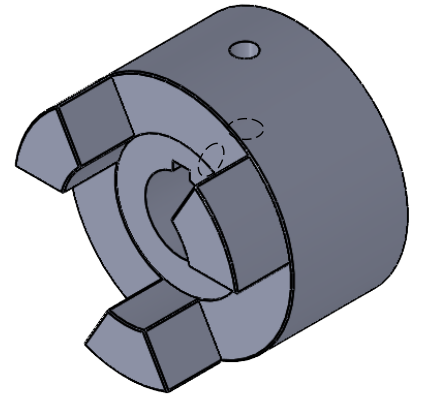

SECTION A-A

(2) 3/8-16 UNC

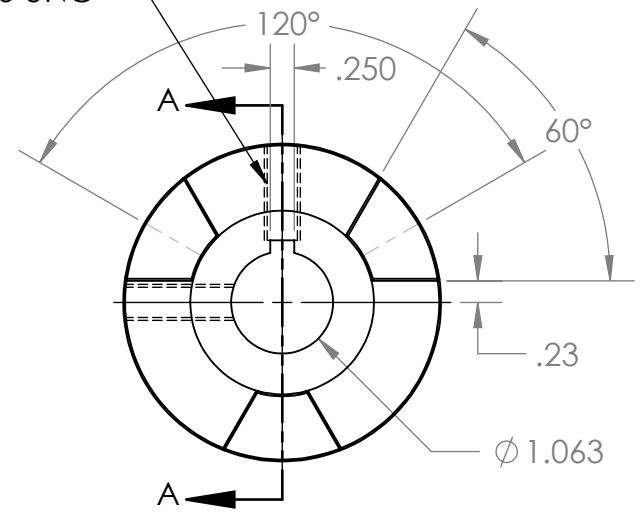

A

A

PROPRIETARY AND CONFIDENTIAL
 THE INFORMATION CONTAINED IN THIS DRAWING IS THE SOLE PROPERTY OF MASTERDRIVE INC. ANY REPRODUCTION IN PART OR AS A WHOLE WITHOUT THE WRITTEN PERMISSION OF MASTERDRIVE INC IS PROHIBITED.

				NAME	DATE
				EDG	02/04/22
				CHECKED	
				ENG APPR.	
				MFG APPR.	
				Q.A.	
				COMMENTS:	
				INTERPRET GEOMETRIC TOLERANCING PER:	
				MATERIAL HT200 (Cast Iron)	
				FINISH Black Phosphate	
	NEXT ASSY	USED ON			
	APPLICATION			DO NOT SCALE DRAWING	



TITLE:		
L110-1-1/16		
SIZE	DWG. NO.	REV
A	L110-1.063	
SCALE: 1:2	WEIGHT:	SHEET 1 OF 1

2

1