

2

1

B

B

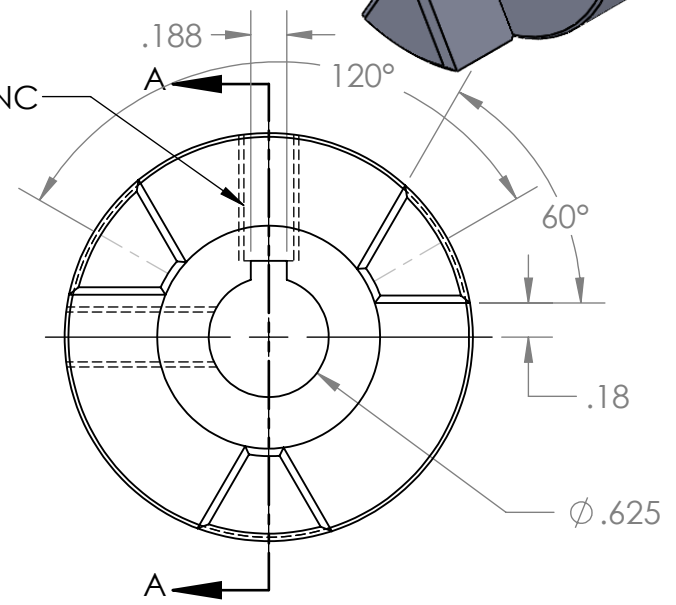
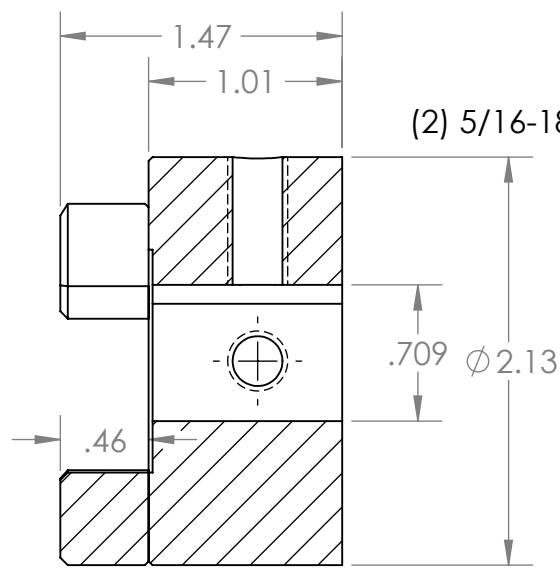
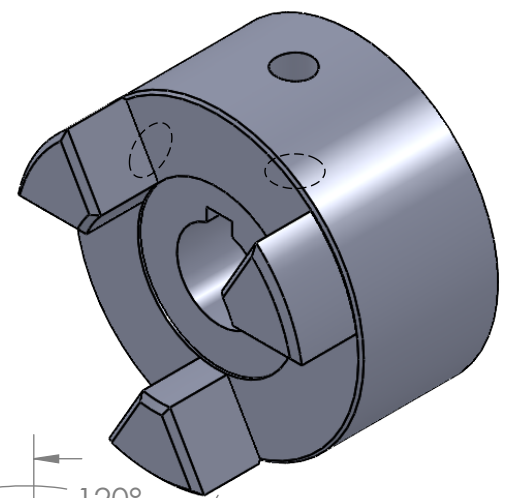

SECTION A-A

A

A

PROPRIETARY AND CONFIDENTIAL
 THE INFORMATION CONTAINED IN THIS DRAWING IS THE SOLE PROPERTY OF MASTERDRIVE, INC. ANY REPRODUCTION IN PART OR AS A WHOLE WITHOUT THE WRITTEN PERMISSION OF MASTERDRIVE, INC. IS PROHIBITED.

			NAME	DATE
			EDG	01/24/22
			CHECKED	
			ENG APPR.	
			MFG APPR.	
			Q.A.	
			COMMENTS:	
		INTERPRET GEOMETRIC TOLERANCING PER:		
		MATERIAL	Powdered Metal	
		FINISH	None	
NEXT ASSY	USED ON			
APPLICATION		DO NOT SCALE DRAWING		



TITLE:		
<h1>L095-5/8</h1>		
SIZE	DWG. NO.	REV
A	L095-0.625	
SCALE: 1:1	WEIGHT:	SHEET 1 OF 1

2

1