

2

1

B

B

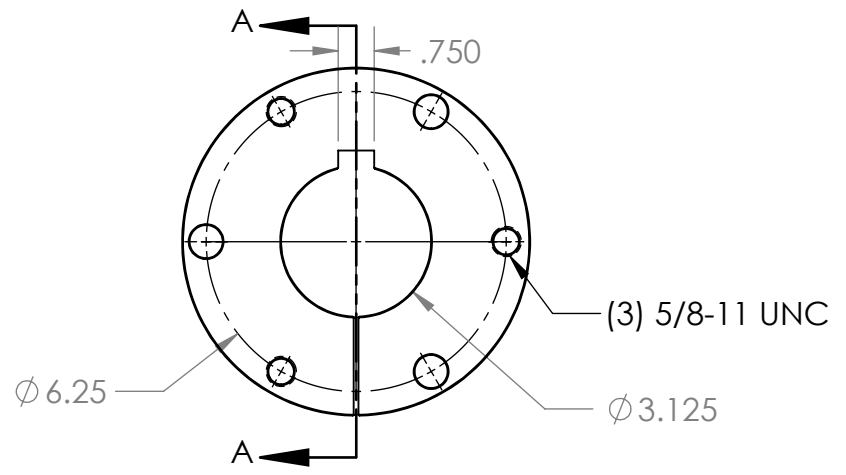
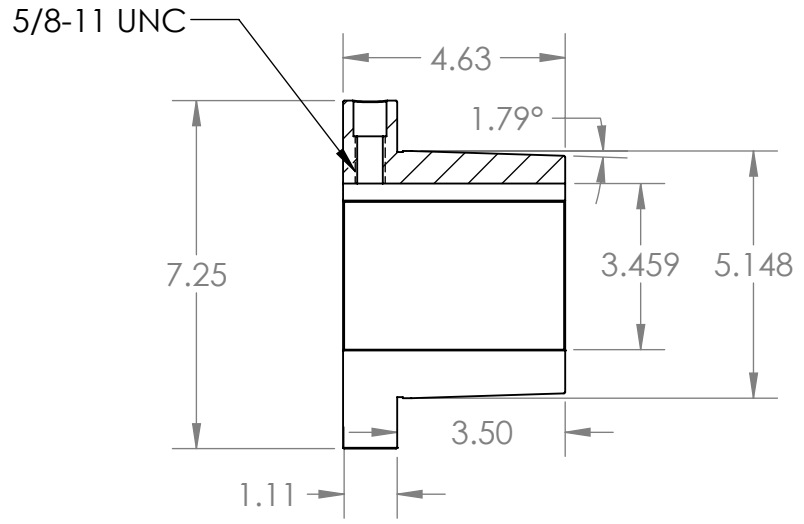
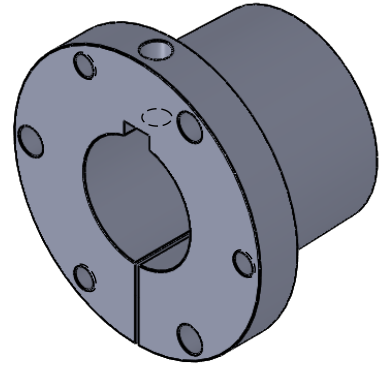

SECTION A-A

A

A

PROPRIETARY AND CONFIDENTIAL
 THE INFORMATION CONTAINED IN THIS DRAWING IS THE SOLE PROPERTY OF MASTERDRIVE, INC. ANY REPRODUCTION IN PART OR AS A WHOLE WITHOUT THE WRITTEN PERMISSION OF MASTERDRIVE, INC. IS PROHIBITED.

				NAME	DATE
				EDG	07/29/20
				CHECKED	
				ENG APPR.	
				MFG APPR.	
				Q.A.	
				COMMENTS:	
				INTERPRET GEOMETRIC TOLERANCING PER:	
				MATERIAL QT450-10 (Ductile Iron)	
				FINISH Black Phosphate	
	NEXT ASSY	USED ON			
	APPLICATION				DO NOT SCALE DRAWING



TITLE:		
<h1>J3.1/8</h1>		
SIZE	DWG. NO.	REV
A	J3.125	
SCALE: 1:4	WEIGHT:	SHEET 1 OF 1

2

1