

2

1

B

B

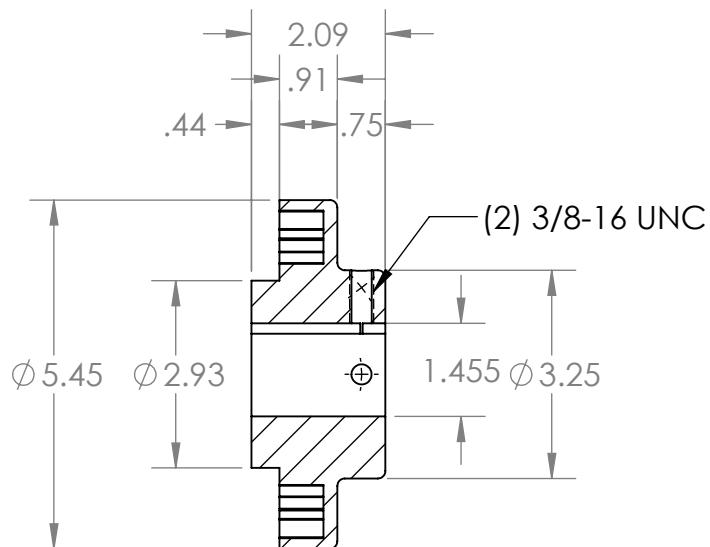
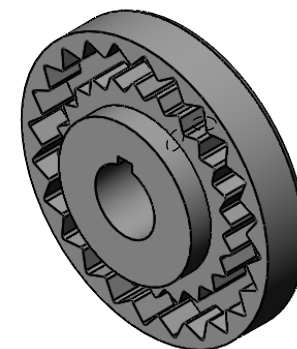

SECTION A-A

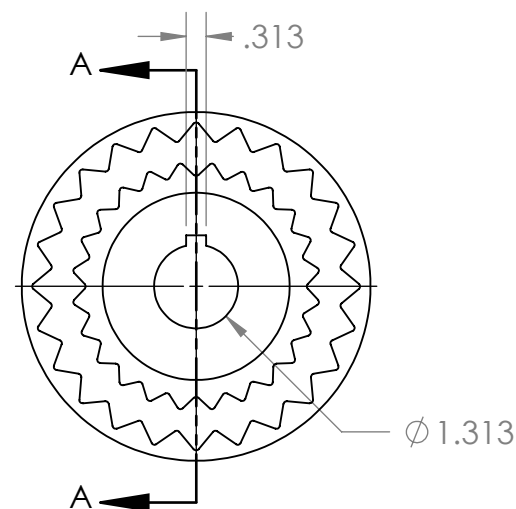

A

A

PROPRIETARY AND CONFIDENTIAL
 THE INFORMATION CONTAINED IN THIS DRAWING IS THE SOLE PROPERTY OF MASTERDRIVE, INC. ANY REPRODUCTION IN PART OR AS A WHOLE WITHOUT THE WRITTEN PERMISSION OF MASTERDRIVE, INC. IS PROHIBITED.

		INTERPRET GEOMETRIC TOLERANCING PER:	
		MATERIAL	HT200 (Cast Iron)
		FINISH	Grey Paint
NEXT ASSY	USED ON		
APPLICATION		DO NOT SCALE DRAWING	

	NAME	DATE
DRAWN	EDG	05/02/22
CHECKED		
ENG APPR.		
MFG APPR.		
Q.A.		
COMMENTS:		



TITLE:		
8S-1-5/16		
SIZE	DWG. NO.	REV
A	8S-1.313	
SCALE: 1:3	WEIGHT:	SHEET 1 OF 1

2

1