

2

1

B

B

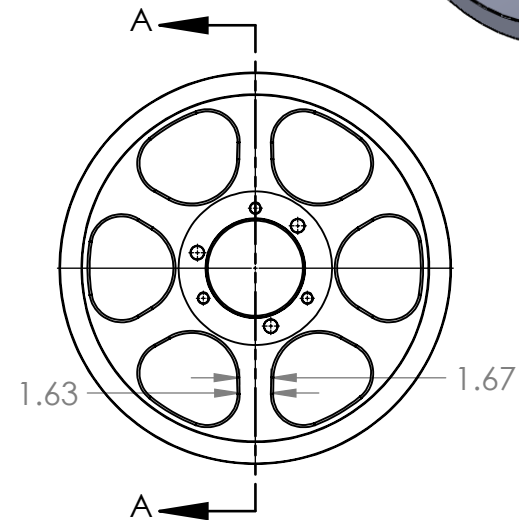
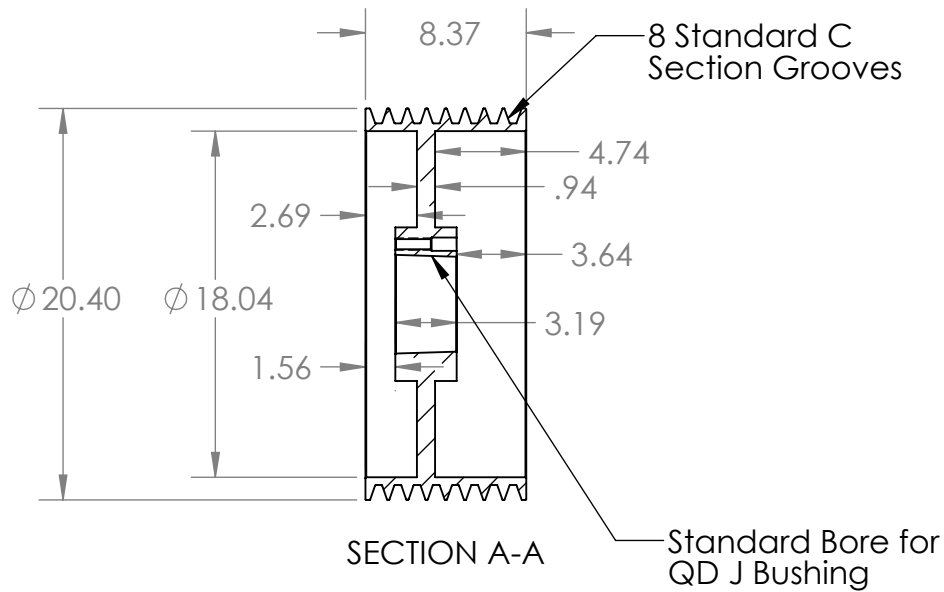
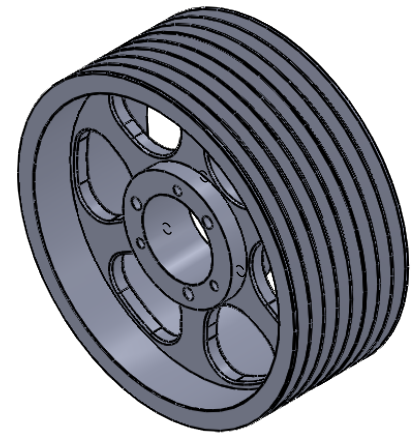

A

A

PROPRIETARY AND CONFIDENTIAL
 THE INFORMATION CONTAINED IN THIS DRAWING IS THE SOLE PROPERTY OF <INSERT COMPANY NAME HERE>. ANY REPRODUCTION IN PART OR AS A WHOLE WITHOUT THE WRITTEN PERMISSION OF <INSERT COMPANY NAME HERE> IS PROHIBITED.

		INTERPRET GEOMETRIC TOLERANCING PER:	
		MATERIAL HT200 (Cast Iron)	
		FINISH Grey Paint	
NEXT ASSY	USED ON		
APPLICATION		DO NOT SCALE DRAWING	

	NAME	DATE
DRAWN	EDG	06/02/20
CHECKED		
ENG APPR.		
MFG APPR.		
Q.A.		
COMMENTS:		



TITLE: 8C200J		
SIZE A	DWG. NO. 8C200J	REV
SCALE: 1:10	WEIGHT:	SHEET 1 OF 1

2

1