

2

1

B

B

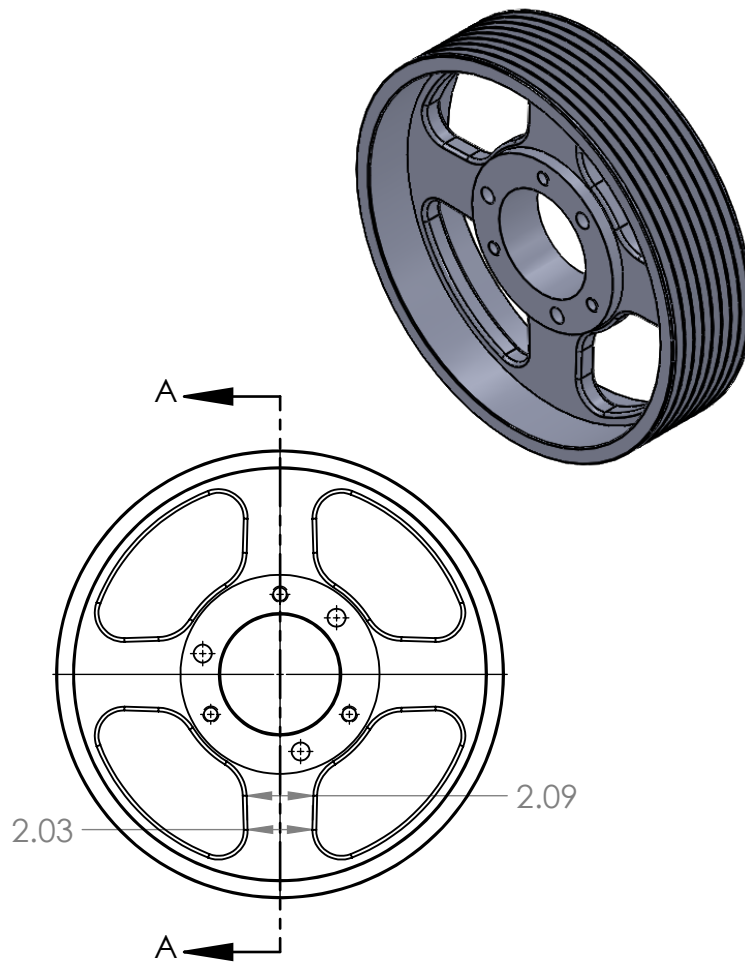
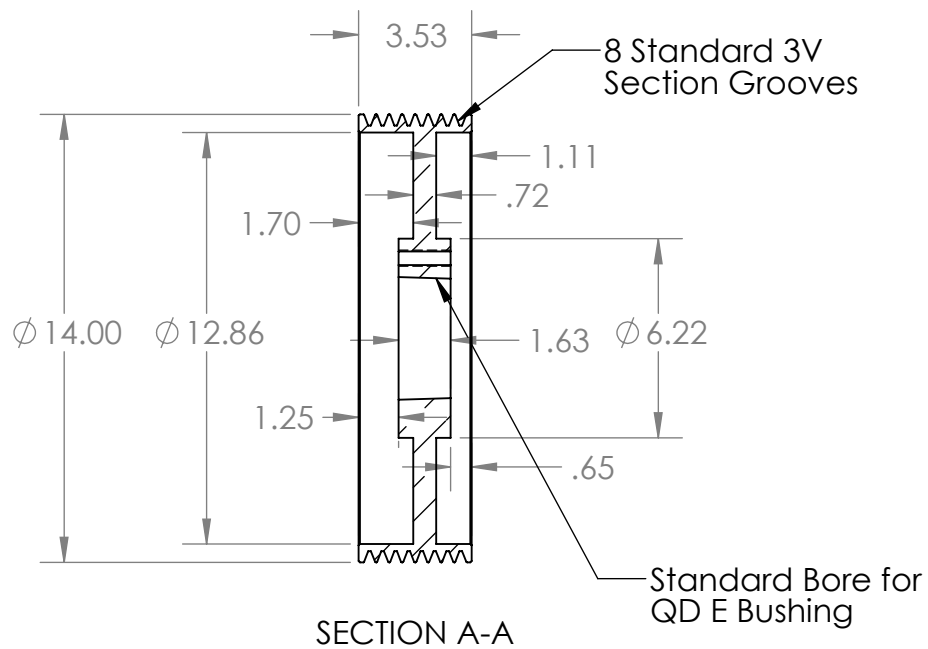

A

A

PROPRIETARY AND CONFIDENTIAL
 THE INFORMATION CONTAINED IN THIS DRAWING IS THE SOLE PROPERTY OF <INSERT COMPANY NAME HERE>. ANY REPRODUCTION IN PART OR AS A WHOLE WITHOUT THE WRITTEN PERMISSION OF <INSERT COMPANY NAME HERE> IS PROHIBITED.

				NAME	DATE
				EDG	06/17/20
				CHECKED	
				ENG APPR.	
				MFG APPR.	
				Q.A.	
				COMMENTS:	
				INTERPRET GEOMETRIC TOLERANCING PER:	
				MATERIAL HT200 (Cast Iron)	
				FINISH Grey Paint	
	NEXT ASSY	USED ON			
	APPLICATION				
				DO NOT SCALE DRAWING	



TITLE:		
8/3V1400E		
SIZE	DWG. NO.	REV
A	83V1400E	
SCALE: 1:6	WEIGHT:	SHEET 1 OF 1

2

1