

2

1

B

B

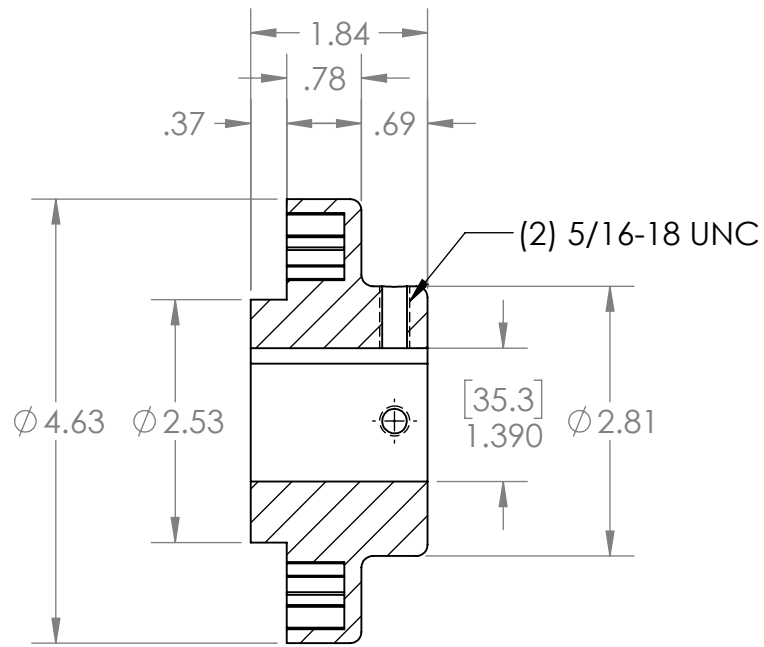

SECTION A-A

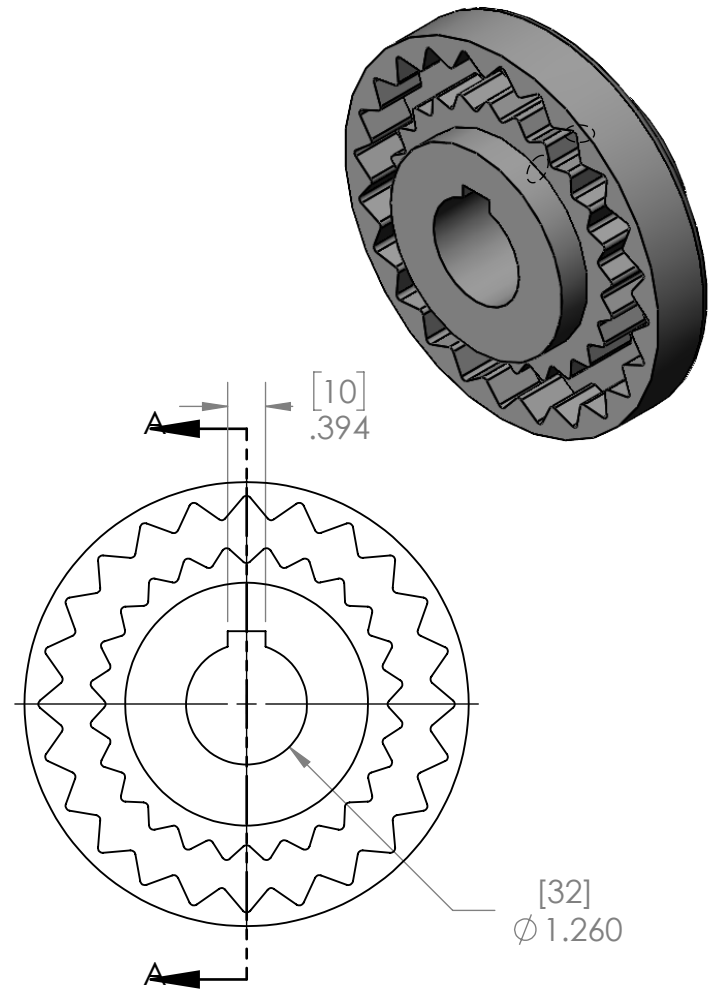

A

A

PROPRIETARY AND CONFIDENTIAL
 THE INFORMATION CONTAINED IN THIS DRAWING IS THE SOLE PROPERTY OF MASTERDRIVE, INC. ANY REPRODUCTION IN PART OR AS A WHOLE WITHOUT THE WRITTEN PERMISSION OF MASTERDRIVE, INC. IS PROHIBITED.

			INTERPRET GEOMETRIC TOLERANCING PER:
			MATERIAL HT200 (Cast Iron)
			FINISH Grey Paint
NEXT ASSY	USED ON		
APPLICATION			DO NOT SCALE DRAWING

	NAME	DATE
DRAWN	EDG	05/19/22
CHECKED		
ENG APPR.		
MFG APPR.		
Q.A.		
COMMENTS:		



TITLE: 7S-32MM		
SIZE A	DWG. NO. 7S-32MM	REV
SCALE: 1:2	WEIGHT:	SHEET 1 OF 1

2

1