

2

1

B

B

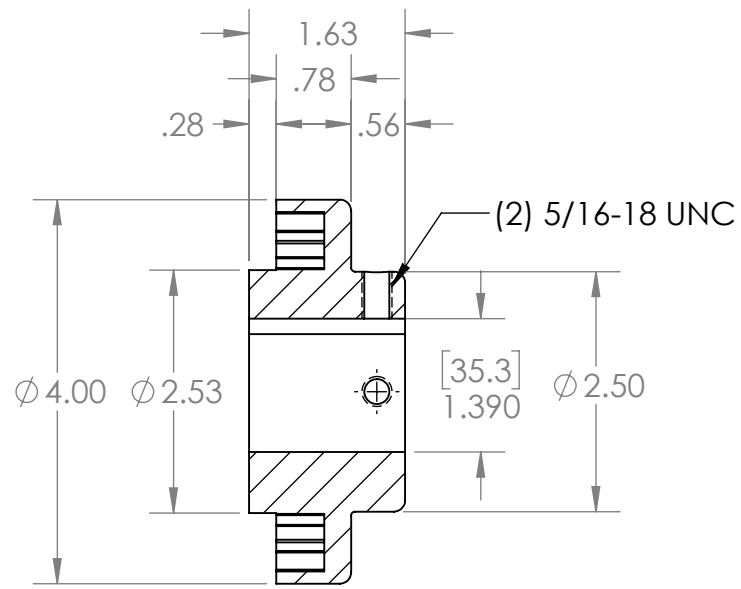
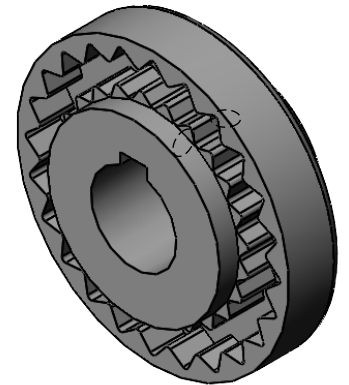

SECTION A-A

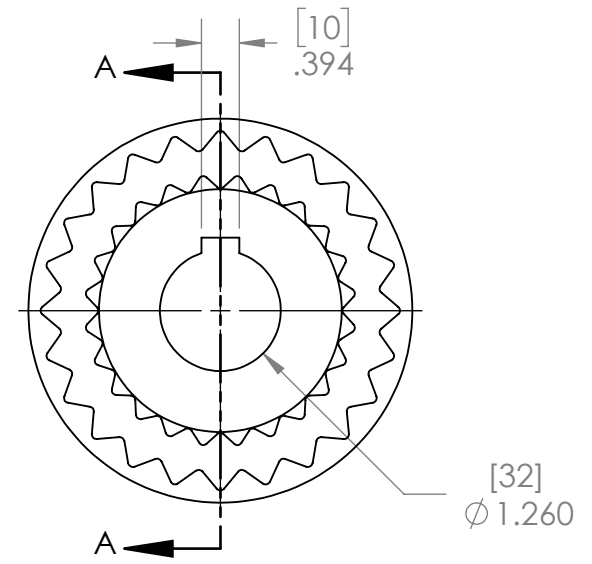

A

A

PROPRIETARY AND CONFIDENTIAL
 THE INFORMATION CONTAINED IN THIS DRAWING IS THE SOLE PROPERTY OF MASTERDRIVE, INC. ANY REPRODUCTION IN PART OR AS A WHOLE WITHOUT THE WRITTEN PERMISSION OF MASTERDRIVE, INC. IS PROHIBITED.

				NAME	DATE
				EDG	05/18/22
				CHECKED	
				ENG APPR.	
				MFG APPR.	
				Q.A.	
				COMMENTS:	
				INTERPRET GEOMETRIC TOLERANCING PER:	
				MATERIAL HT200 (Cast Iron)	
				FINISH Grey Paint	
	NEXT ASSY	USED ON			
	APPLICATION				
					DO NOT SCALE DRAWING



TITLE:		
6S-32MM		
SIZE	DWG. NO.	REV
A	6S-32MM	
SCALE: 1:2	WEIGHT:	SHEET 1 OF 1

2

1