

2

1

B

B

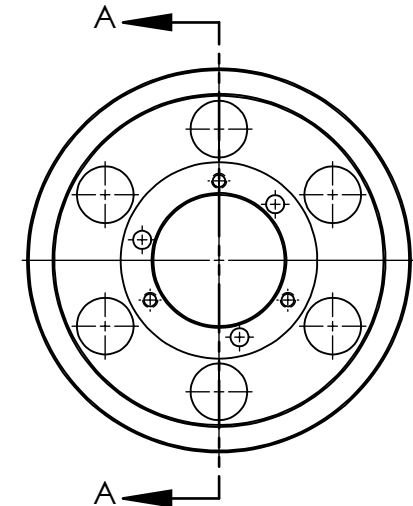
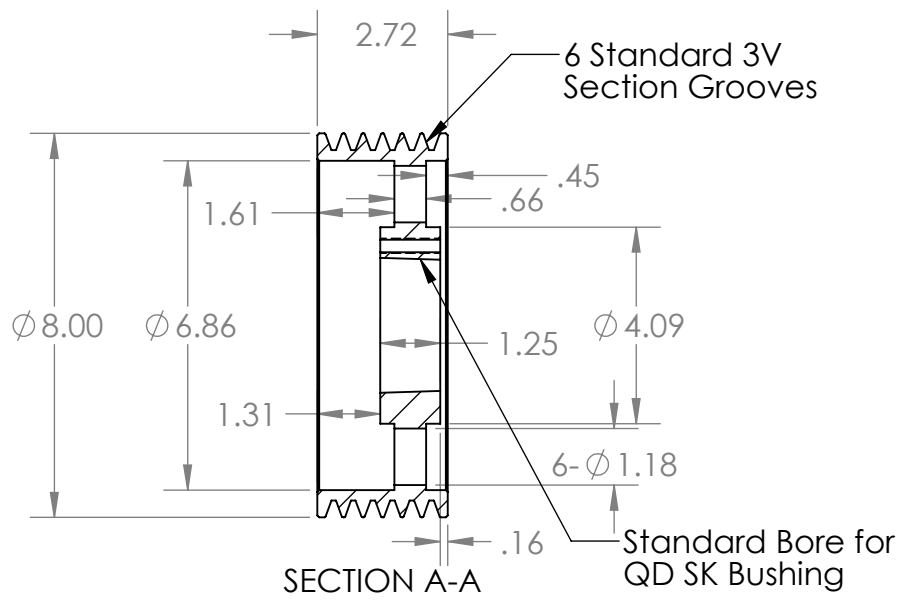
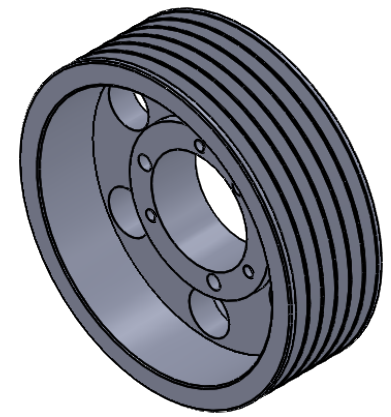

A

A

**PROPRIETARY AND CONFIDENTIAL**  
 THE INFORMATION CONTAINED IN THIS DRAWING IS THE SOLE PROPERTY OF <INSERT COMPANY NAME HERE>. ANY REPRODUCTION IN PART OR AS A WHOLE WITHOUT THE WRITTEN PERMISSION OF <INSERT COMPANY NAME HERE> IS PROHIBITED.

				NAME	DATE
				DRAWN	EDG 06/16/20
				CHECKED	
				ENG APPR.	
				MFG APPR.	
				Q.A.	
				COMMENTS:	
			INTERPRET GEOMETRIC TOLERANCING PER:		
			MATERIAL		
			HT200 (Cast Iron)		
			FINISH		
			Grey Paint		
NEXT ASSY	USED ON				
APPLICATION			DO NOT SCALE DRAWING		



TITLE:		
6/3V800SK		
SIZE	DWG. NO.	REV
<b>A</b>	63V800SK	
SCALE: 1:4	WEIGHT:	SHEET 1 OF 1

2

1