

2

1

B

B

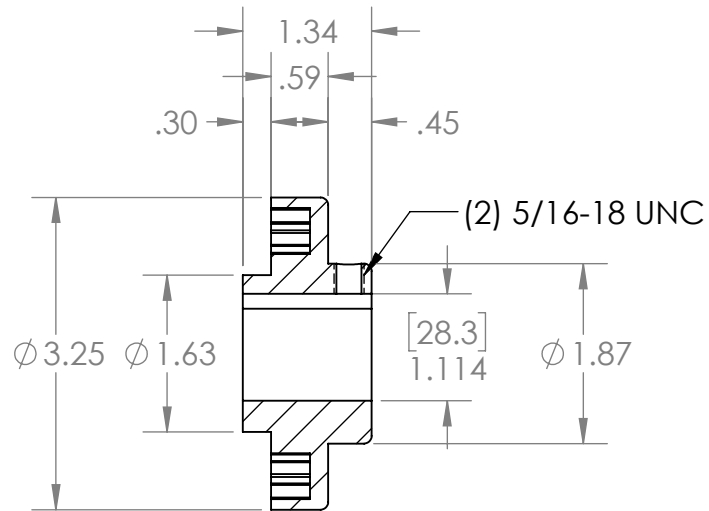
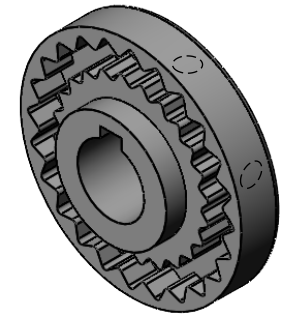

SECTION A-A

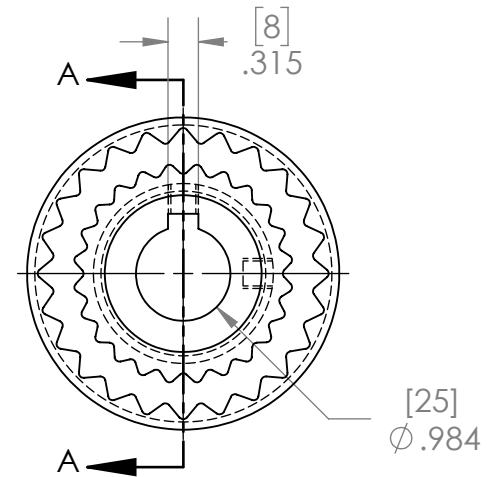

A

A

PROPRIETARY AND CONFIDENTIAL
 THE INFORMATION CONTAINED IN THIS DRAWING IS THE SOLE PROPERTY OF MASTERDRIVE, INC. ANY REPRODUCTION IN PART OR AS A WHOLE WITHOUT THE WRITTEN PERMISSION OF MASTERDRIVE, INC. IS PROHIBITED.

				NAME	DATE
				EDG	05/13/22
				CHECKED	
				ENG APPR.	
				MFG APPR.	
				Q.A.	
				COMMENTS:	
		INTERPRET GEOMETRIC TOLERANCING PER:			
		MATERIAL	Powdered Metal		
		FINISH	None		
NEXT ASSY	USED ON				
APPLICATION		DO NOT SCALE DRAWING			



TITLE:
5S-25MM

SIZE **A** DWG. NO. **5S-25MM** REV

SCALE: 1:2 WEIGHT: SHEET 1 OF 1

2

1