

2

1

B

B

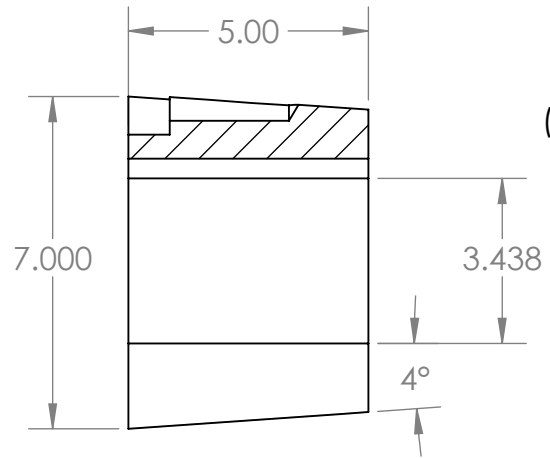
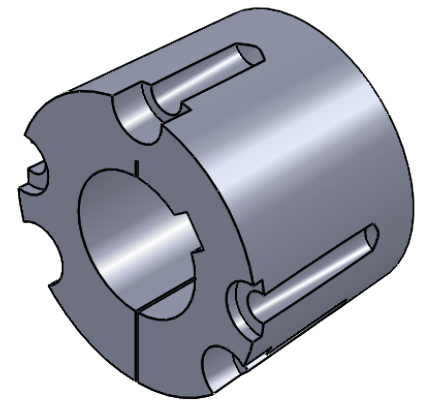

SECTION B-B

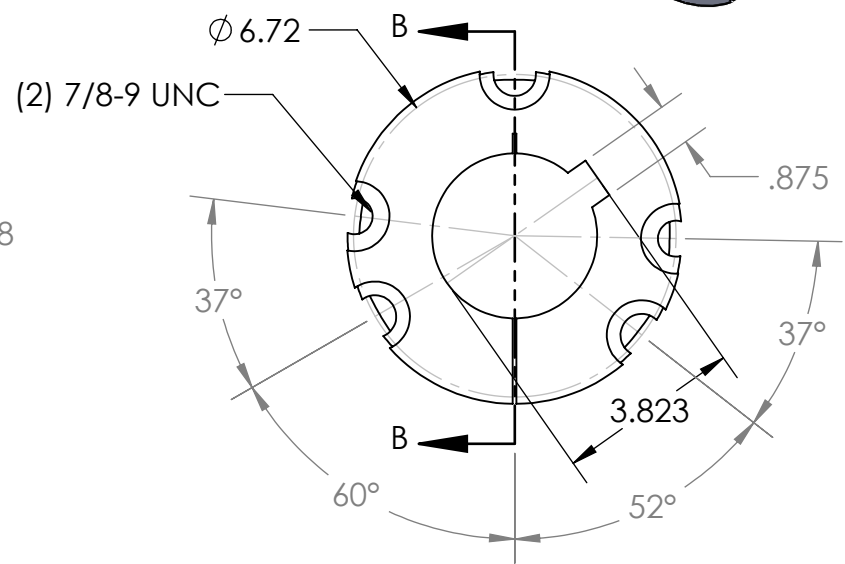

A

A

**PROPRIETARY AND CONFIDENTIAL**  
 THE INFORMATION CONTAINED IN THIS DRAWING IS THE SOLE PROPERTY OF MASTERDRIVE, INC. ANY REPRODUCTION IN PART OR AS A WHOLE WITHOUT THE WRITTEN PERMISSION OF MASTERDRIVE, INC. IS PROHIBITED.

				NAME	DATE
				EDG	11/24/20
				CHECKED	
				ENG APPR.	
				MFG APPR.	
				Q.A.	
				COMMENTS:	
				INTERPRET GEOMETRIC TOLERANCING PER:	
				MATERIAL HT200 (Cast Iron)	
				FINISH Black Phosphate	
	NEXT ASSY	USED ON			
	APPLICATION				DO NOT SCALE DRAWING



TITLE:  
**5050-3.7/16**

SIZE DWG. NO. REV  
**A** 5050-3.438

SCALE: 1:4 WEIGHT: SHEET 1 OF 1

2

1