

2

1

B

B

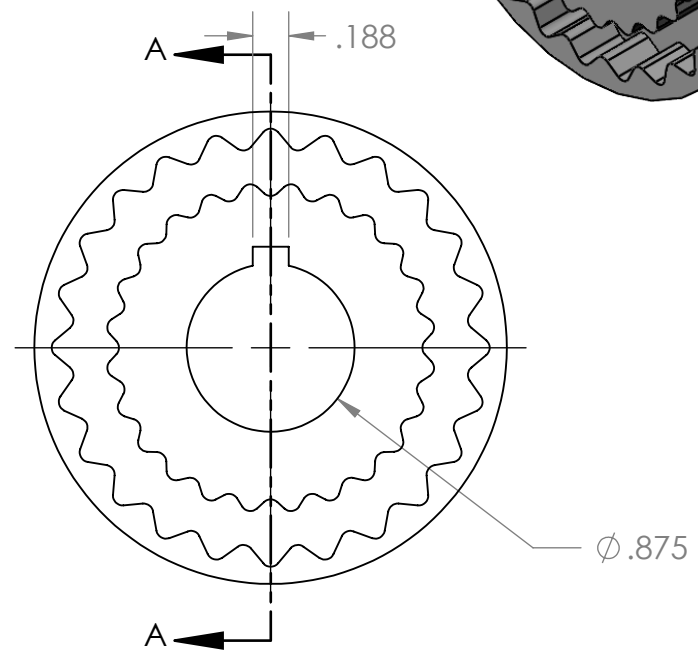
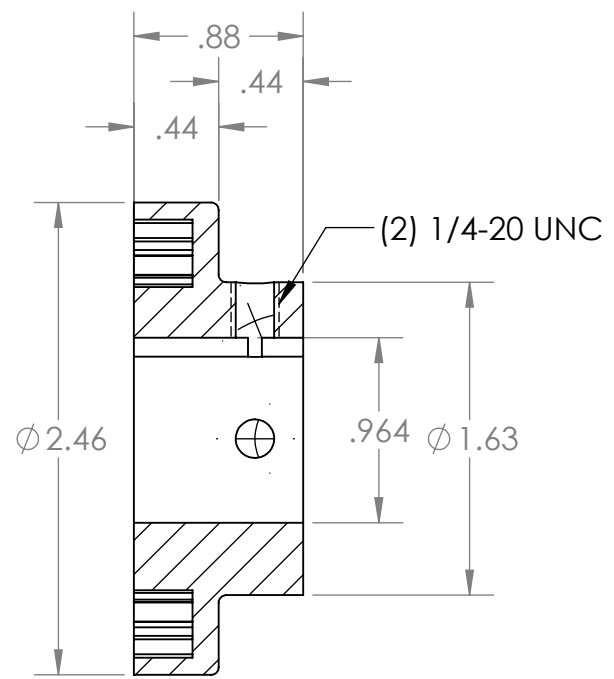
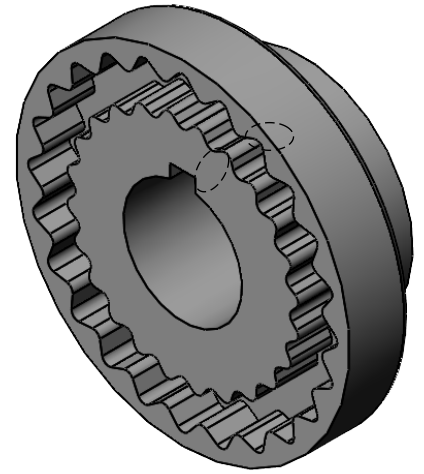

SECTION A-A

A

A

PROPRIETARY AND CONFIDENTIAL
 THE INFORMATION CONTAINED IN THIS DRAWING IS THE SOLE PROPERTY OF MASTERDRIVE, INC. ANY REPRODUCTION IN PART OR AS A WHOLE WITHOUT THE WRITTEN PERMISSION OF MASTERDRIVE, INC. IS PROHIBITED.

				NAME	DATE
				EDG	05/20/22
				CHECKED	
				ENG APPR.	
				MFG APPR.	
				Q.A.	
				COMMENTS:	
		INTERPRET GEOMETRIC TOLERANCING PER:			
		MATERIAL			
		Powdered Metal			
		FINISH			
		None			
NEXT ASSY	USED ON				
APPLICATION		DO NOT SCALE DRAWING			



TITLE:		
4J-7/8		
SIZE	DWG. NO.	REV
A	4J-0.875	
SCALE: 1:1	WEIGHT:	SHEET 1 OF 1

2

1