

2

1

B

B

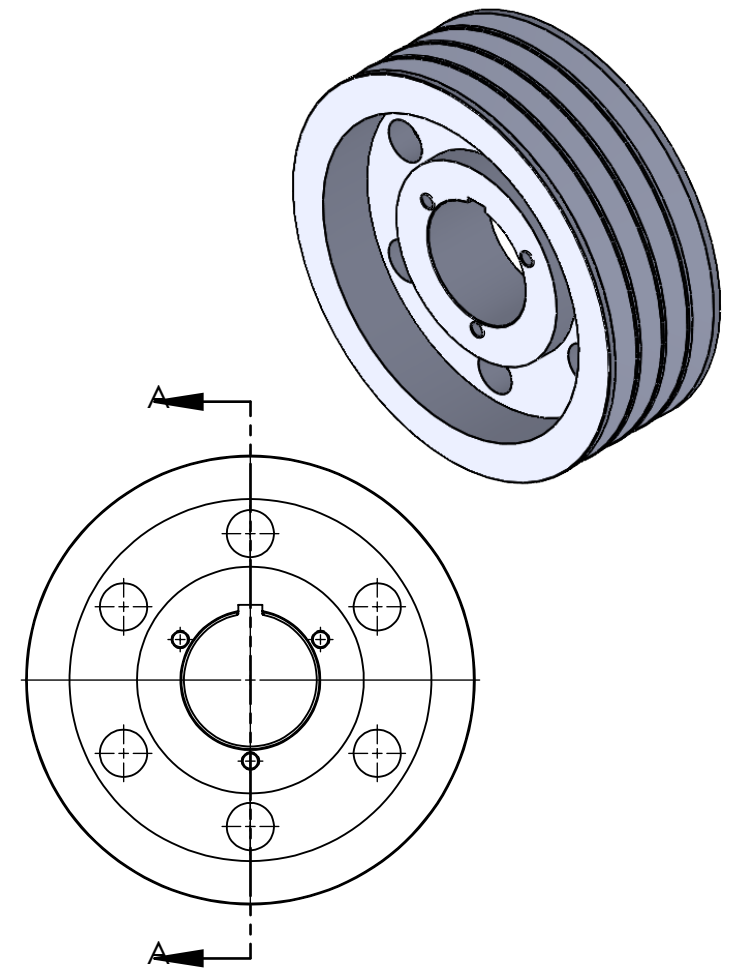
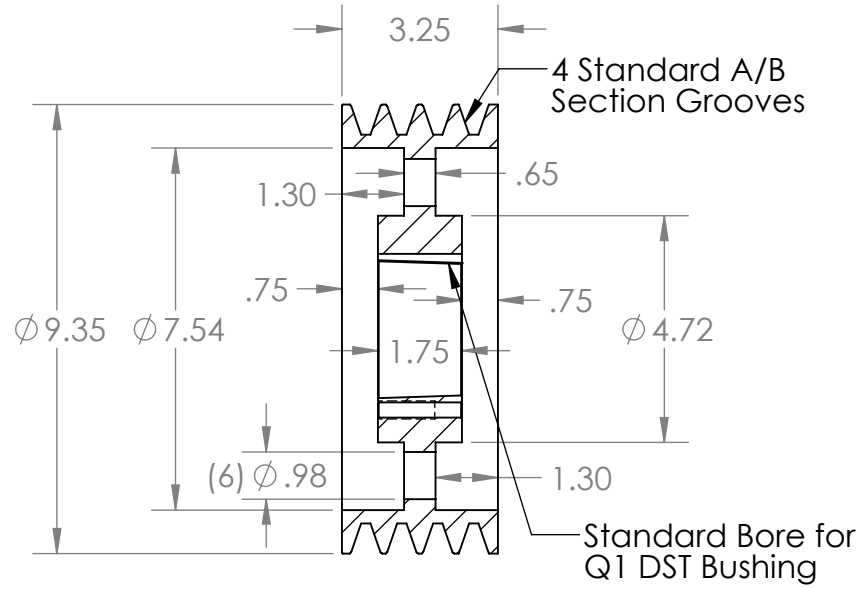

A

A

PROPRIETARY AND CONFIDENTIAL
 THE INFORMATION CONTAINED IN THIS DRAWING IS THE SOLE PROPERTY OF MASTERDRIVE, INC. ANY REPRODUCTION IN PART OR AS A WHOLE WITHOUT THE WRITTEN PERMISSION OF MASTERDRIVE, INC. IS PROHIBITED.

			INTERPRET GEOMETRIC TOLERANCING PER:
			MATERIAL HT200 (Cast Iron)
			FINISH Grey Paint
NEXT ASSY	USED ON		
APPLICATION		DO NOT SCALE DRAWING	

	NAME	DATE
DRAWN	EDG	08/30/21
CHECKED		
ENG APPR.		
MFG APPR.		
Q.A.		
COMMENTS:		



TITLE:		
4B90Q1		
SIZE	DWG. NO.	REV
A	4B90Q1	
SCALE: 1:4	WEIGHT:	SHEET 1 OF 1

2

1