

2

1

B

B

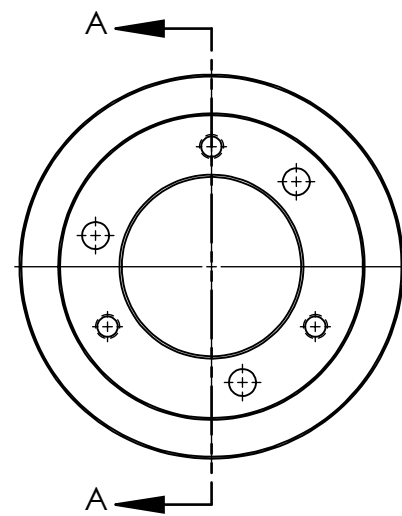
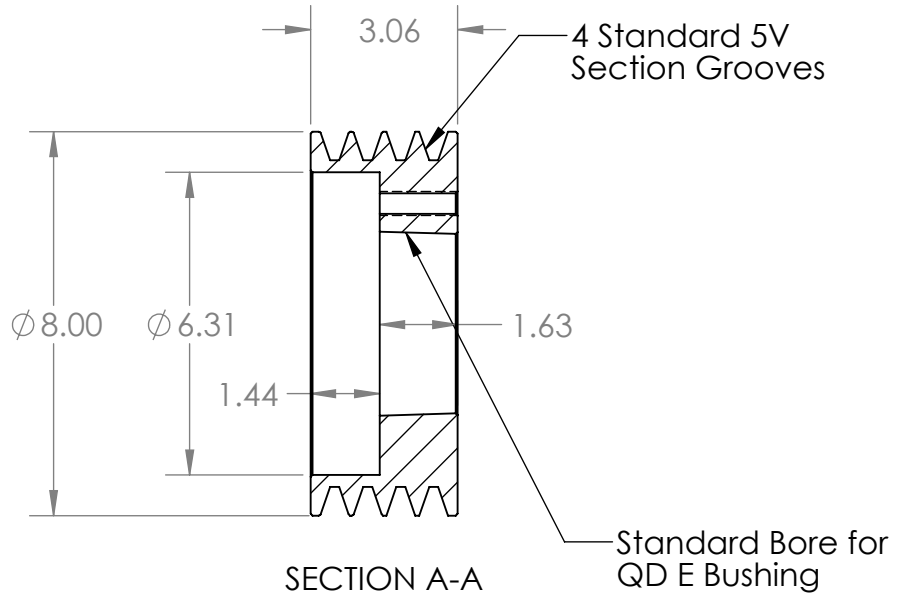
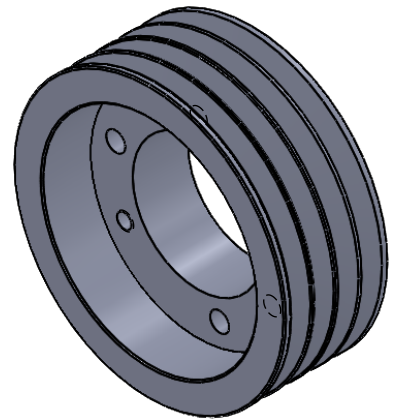

A

A

PROPRIETARY AND CONFIDENTIAL
 THE INFORMATION CONTAINED IN THIS DRAWING IS THE SOLE PROPERTY OF <INSERT COMPANY NAME HERE>. ANY REPRODUCTION IN PART OR AS A WHOLE WITHOUT THE WRITTEN PERMISSION OF <INSERT COMPANY NAME HERE> IS PROHIBITED.

			NAME	DATE
			EDG	06/29/20
			CHECKED	
			ENG APPR.	
			MFG APPR.	
			Q.A.	
			COMMENTS:	
		INTERPRET GEOMETRIC TOLERANCING PER:		
		MATERIAL	HT200 (Cast Iron)	
		FINISH	Grey Paint	
NEXT ASSY	USED ON			
APPLICATION		DO NOT SCALE DRAWING		



TITLE:		
4/5V800E		
SIZE	DWG. NO.	REV
A	45V800E	
SCALE: 1:4	WEIGHT:	SHEET 1 OF 1

2

1