

2

1

B

B

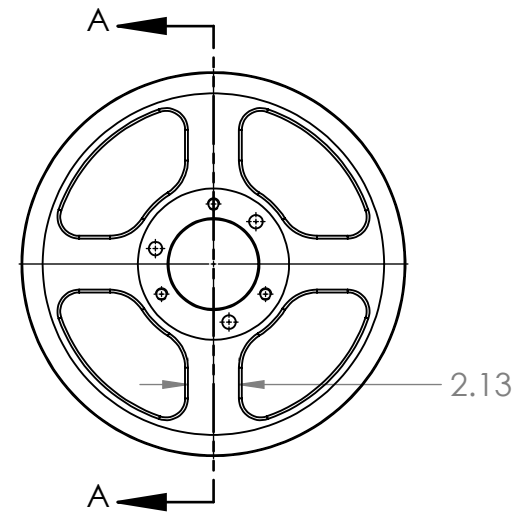
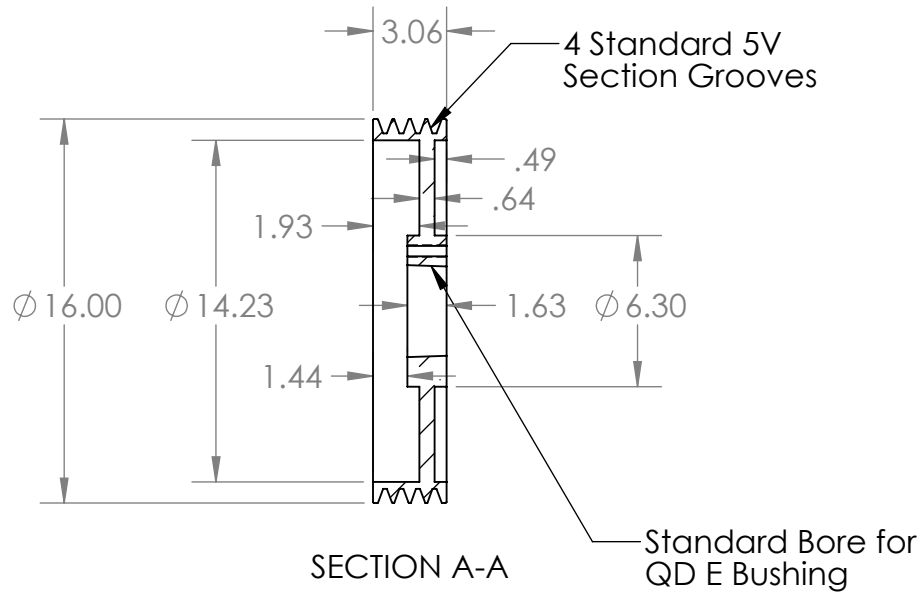
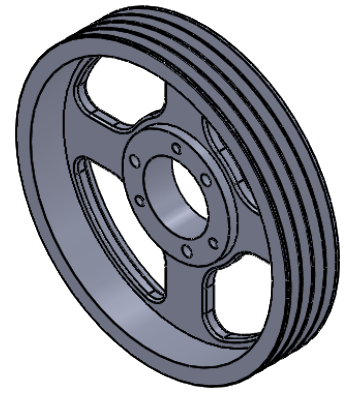

A

A

PROPRIETARY AND CONFIDENTIAL
 THE INFORMATION CONTAINED IN THIS DRAWING IS THE SOLE PROPERTY OF <INSERT COMPANY NAME HERE>. ANY REPRODUCTION IN PART OR AS A WHOLE WITHOUT THE WRITTEN PERMISSION OF <INSERT COMPANY NAME HERE> IS PROHIBITED.

			INTERPRET GEOMETRIC TOLERANCING PER:
			MATERIAL HT200 (Cast Iron)
			FINISH Grey Paint
NEXT ASSY	USED ON		
APPLICATION			DO NOT SCALE DRAWING

	NAME	DATE
DRAWN	EDG	06/29/20
CHECKED		
ENG APPR.		
MFG APPR.		
Q.A.		
COMMENTS:		



TITLE: 4/5V1600E		
SIZE A	DWG. NO. 45V1600E	REV
SCALE: 1:8	WEIGHT:	SHEET 1 OF 1

2

1