

2

1

B

B

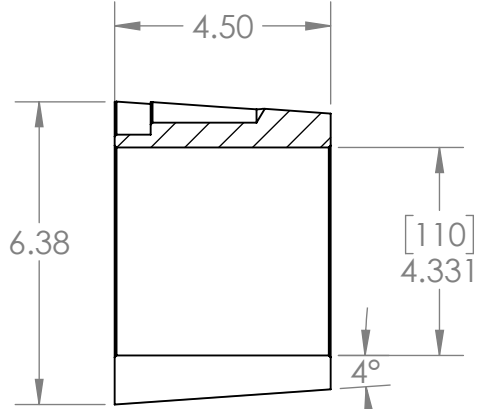
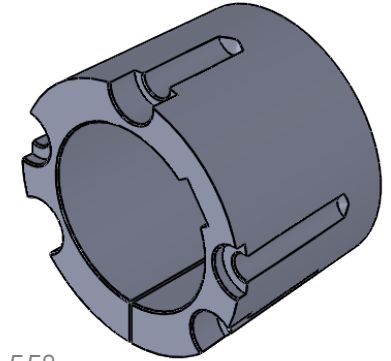

SECTION B-B

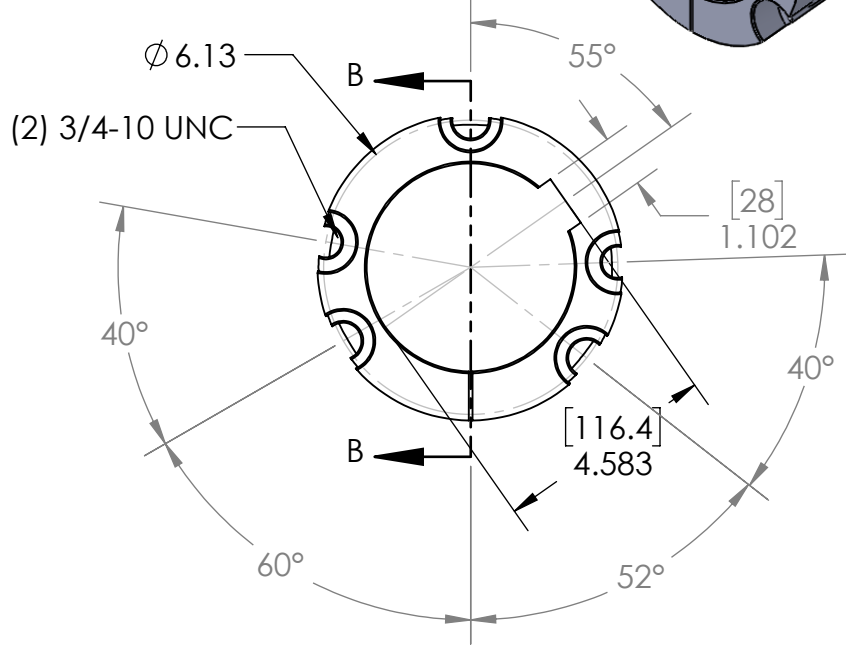

A

A

PROPRIETARY AND CONFIDENTIAL
 THE INFORMATION CONTAINED IN THIS DRAWING IS THE SOLE PROPERTY OF MASTERDRIVE, INC. ANY REPRODUCTION IN PART OR AS A WHOLE WITHOUT THE WRITTEN PERMISSION OF MASTERDRIVE, INC. IS PROHIBITED.

				NAME	DATE
			DRAWN	EDG	01/11/21
			CHECKED		
			ENG APPR.		
			MFG APPR.		
			Q.A.		
			COMMENTS:		
		INTERPRET GEOMETRIC TOLERANCING PER:			
		MATERIAL			
		HT200 (Cast Iron)			
		FINISH			
		Black Phosphate			
NEXT ASSY	USED ON				
APPLICATION		DO NOT SCALE DRAWING			



TITLE:
4545-110MM

SIZE DWG. NO. REV
A 4545-110MM

SCALE: 1:4 WEIGHT: SHEET 1 OF 1

2

1