

2

1

B

B

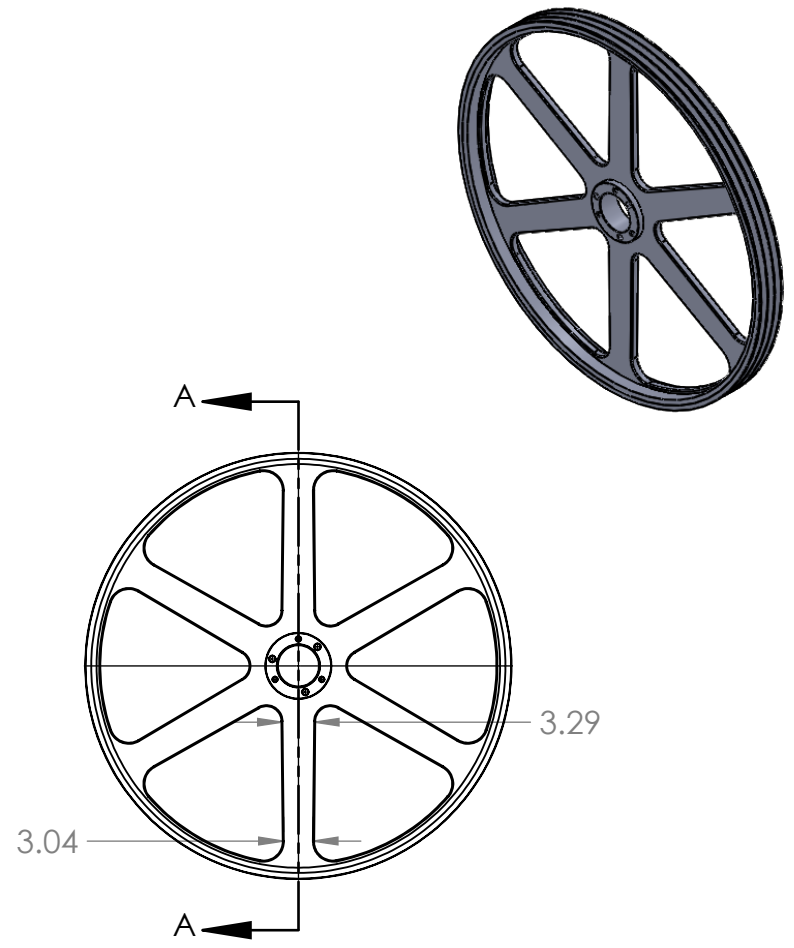
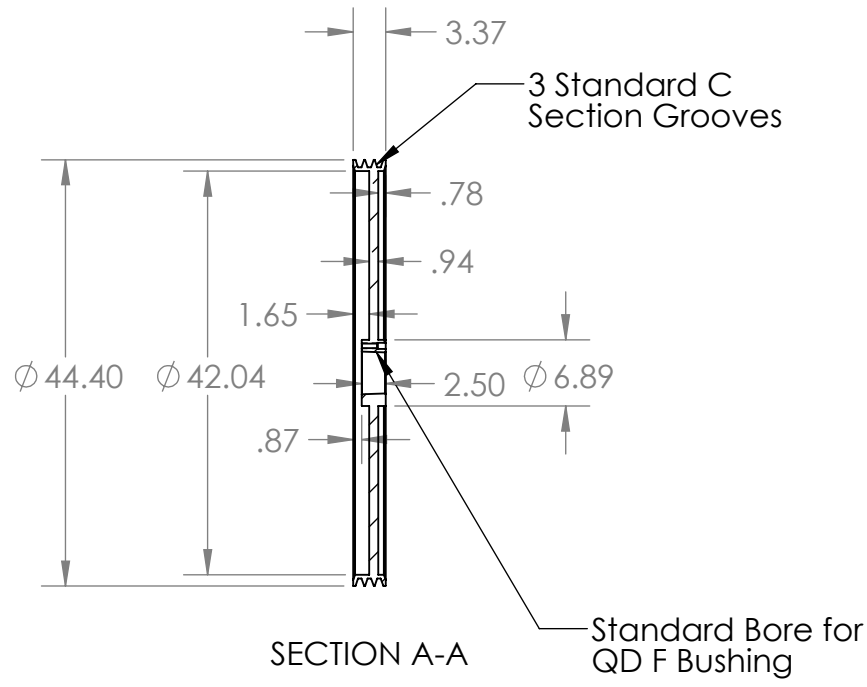

A

A

PROPRIETARY AND CONFIDENTIAL
 THE INFORMATION CONTAINED IN THIS DRAWING IS THE SOLE PROPERTY OF <INSERT COMPANY NAME HERE>. ANY REPRODUCTION IN PART OR AS A WHOLE WITHOUT THE WRITTEN PERMISSION OF <INSERT COMPANY NAME HERE> IS PROHIBITED.

			INTERPRET GEOMETRIC TOLERANCING PER:
			MATERIAL HT200 (Cast Iron)
			FINISH Grey Paint
NEXT ASSY	USED ON		
APPLICATION		DO NOT SCALE DRAWING	

	NAME	DATE
DRAWN	EDG	05/04/20
CHECKED		
ENG APPR.		
MFG APPR.		
Q.A.		
COMMENTS:		

MASTERDRIVE
 POWER TRANSMISSION PRODUCTS

TITLE:
3C440F

SIZE A	DWG. NO. 3C440F	REV
SCALE: 1:20	WEIGHT:	SHEET 1 OF 1

2

1