

2

1

B

B

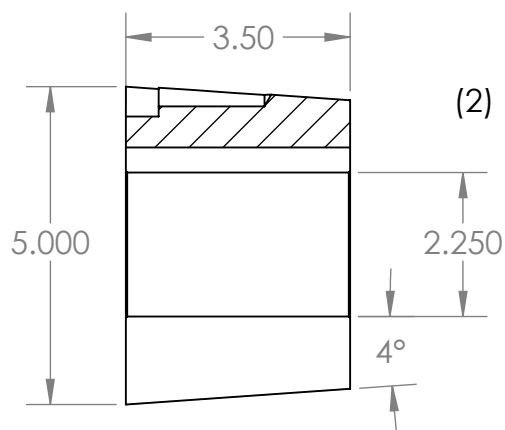
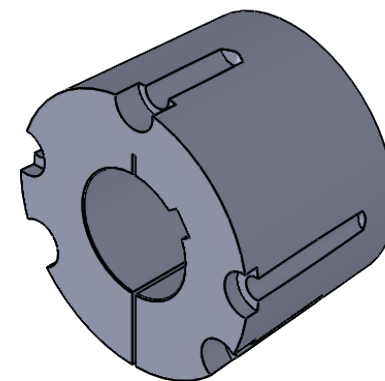

SECTION B-B

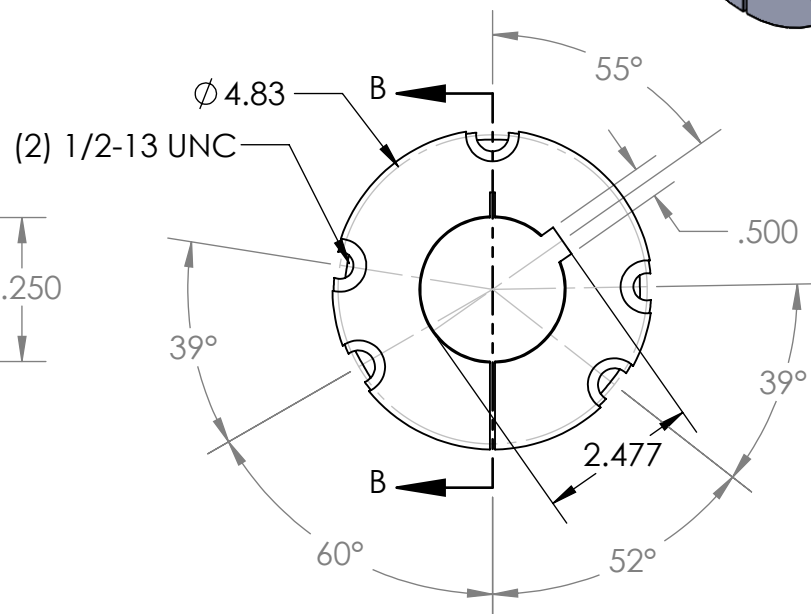

A

A

**PROPRIETARY AND CONFIDENTIAL**  
 THE INFORMATION CONTAINED IN THIS DRAWING IS THE SOLE PROPERTY OF MASTERDRIVE, INC. ANY REPRODUCTION IN PART OR AS A WHOLE WITHOUT THE WRITTEN PERMISSION OF MASTERDRIVE, INC. IS PROHIBITED.

				NAME	DATE
				EDG	11/09/20
				CHECKED	
				ENG APPR.	
				MFG APPR.	
				Q.A.	
				COMMENTS:	
		INTERPRET GEOMETRIC TOLERANCING PER:			
		MATERIAL	HT200 (Cast Iron)		
		FINISH	Black Phosphate		
NEXT ASSY	USED ON	APPLICATION	DO NOT SCALE DRAWING		



TITLE:		
3535-2.1/4		
SIZE	DWG. NO.	REV
<b>A</b>	3535-2.250	
SCALE: 1:3	WEIGHT:	SHEET 1 OF 1

2

1