

2

1

B

B

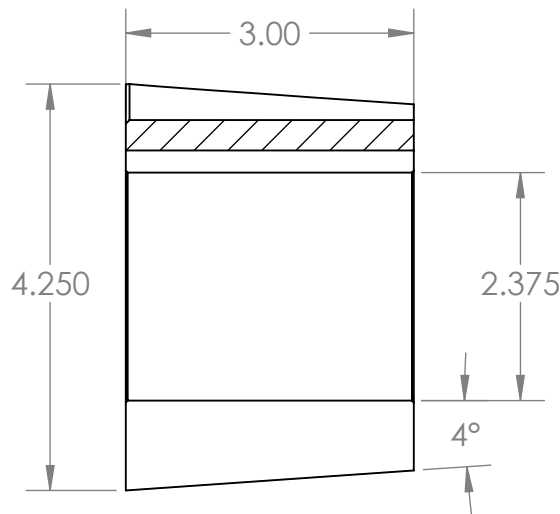
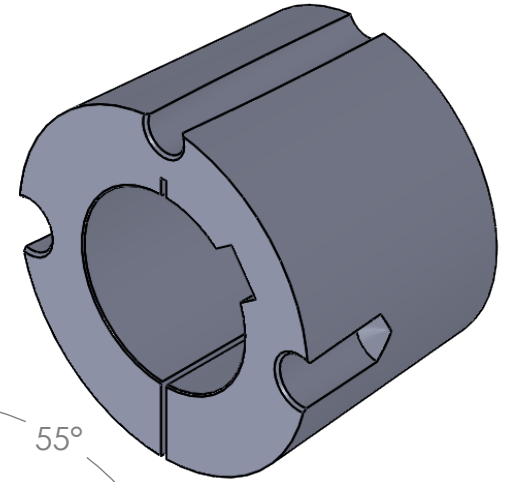

SECTION B-B

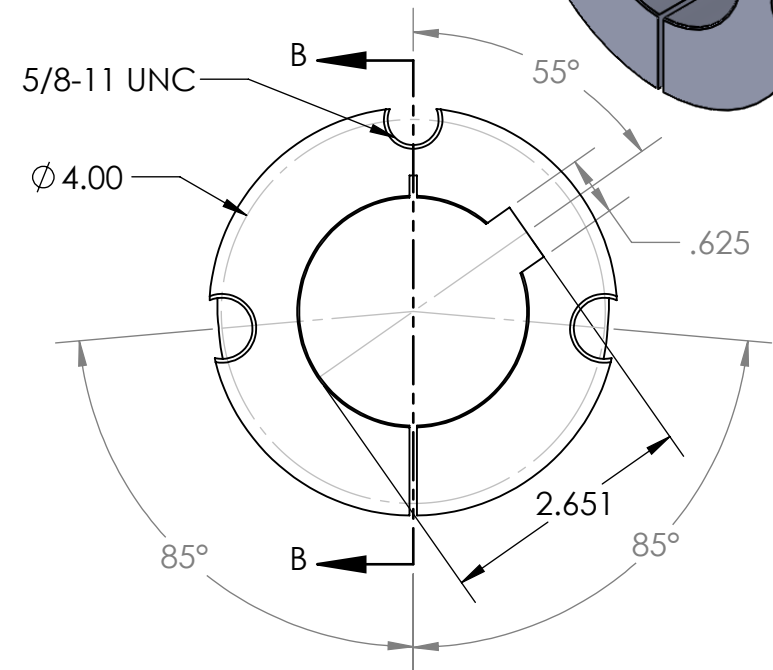

A

A

PROPRIETARY AND CONFIDENTIAL
 THE INFORMATION CONTAINED IN THIS DRAWING IS THE SOLE PROPERTY OF MASTERDRIVE, INC. ANY REPRODUCTION IN PART OR AS A WHOLE WITHOUT THE WRITTEN PERMISSION OF MASTERDRIVE, INC. IS PROHIBITED.

			NAME	DATE
			EDG	11/03/20
			CHECKED	
			ENG APPR.	
			MFG APPR.	
			Q.A.	
			COMMENTS:	
		INTERPRET GEOMETRIC TOLERANCING PER:		
		MATERIAL		
		HT200 (Cast Iron)		
		FINISH		
		Black Phosphate		
NEXT ASSY	USED ON			
APPLICATION		DO NOT SCALE DRAWING		



TITLE:
3030-2.3/8

SIZE	DWG. NO.	REV
A	3030-2.375	
SCALE: 1:2	WEIGHT:	SHEET 1 OF 1

2

1