

2

1

B

B

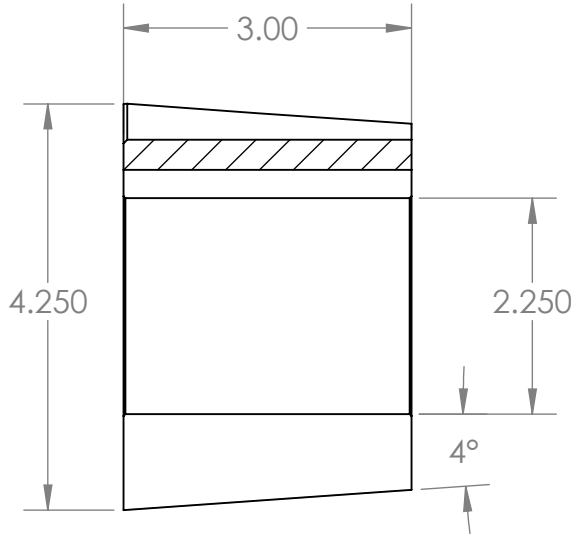
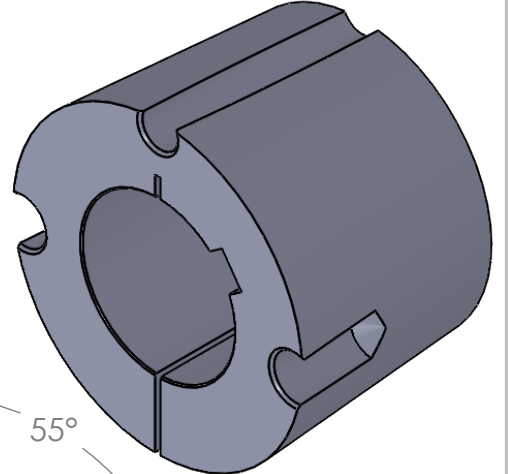

SECTION B-B

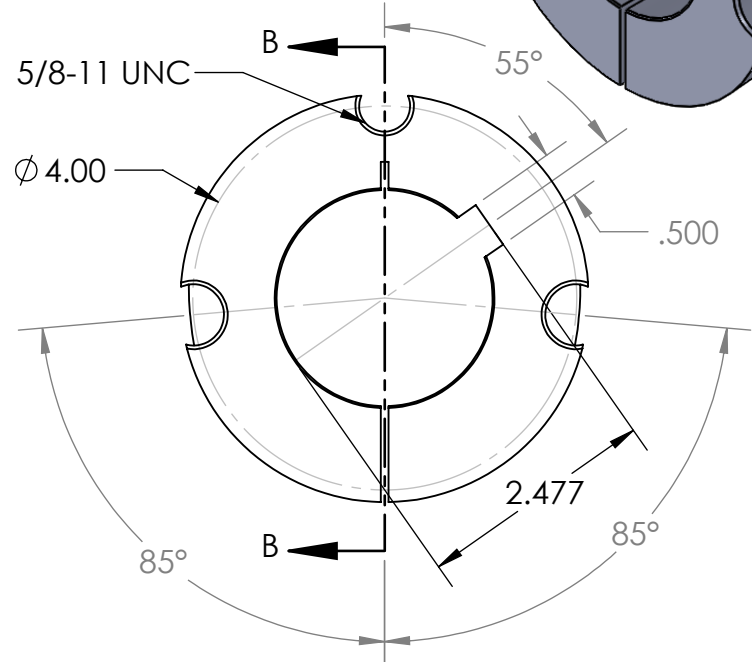

A

A

			NAME	DATE
			EDG	10/30/20
			CHECKED	
			ENG APPR.	
			MFG APPR.	
			Q.A.	
			COMMENTS:	
		INTERPRET GEOMETRIC TOLERANCING PER:		
		MATERIAL		
		HT200 (Cast Iron)		
		FINISH		
		Black Phosphate		
NEXT ASSY	USED ON			
APPLICATION		DO NOT SCALE DRAWING		



TITLE:
3030-2.1/4

SIZE DWG. NO. REV
A 3030-2.250

SCALE: 1:2 WEIGHT: SHEET 1 OF 1

PROPRIETARY AND CONFIDENTIAL
THE INFORMATION CONTAINED IN THIS DRAWING IS THE SOLE PROPERTY OF MASTERDRIVE, INC. ANY REPRODUCTION IN PART OR AS A WHOLE WITHOUT THE WRITTEN PERMISSION OF MASTERDRIVE, INC. IS PROHIBITED.

2

1