

2

1

B

B

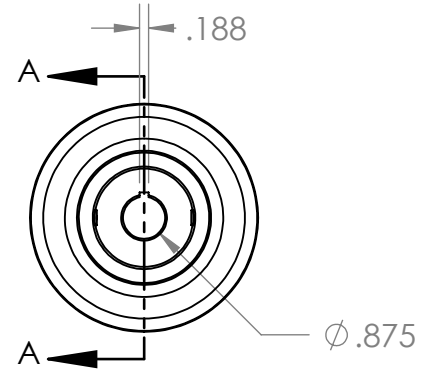
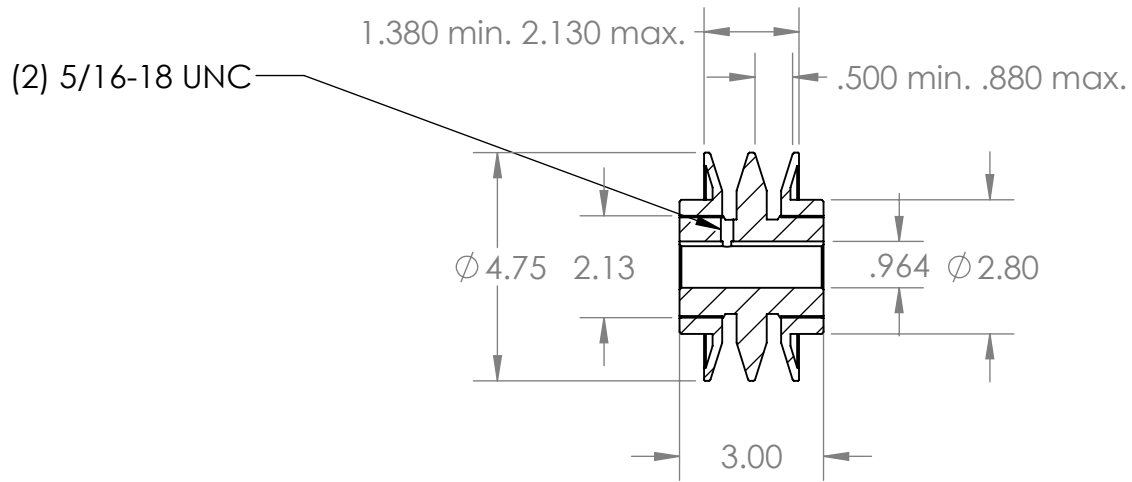
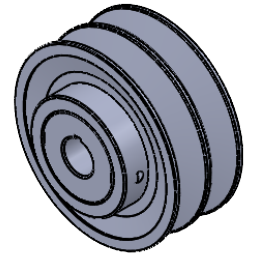

SECTION A-A

A

A

PROPRIETARY AND CONFIDENTIAL
 THE INFORMATION CONTAINED IN THIS DRAWING IS THE SOLE PROPERTY OF MASTERDRIVE, INC. ANY REPRODUCTION IN PART OR AS A WHOLE WITHOUT THE WRITTEN PERMISSION OF MASTERDRIVE, INC. IS PROHIBITED.

				NAME	DATE
				DRAWN	EDG 07/30/21
				CHECKED	
				ENG APPR.	
				MFG APPR.	
				Q.A.	
				COMMENTS:	
				INTERPRET GEOMETRIC TOLERANCING PER:	
				MATERIAL HT200 (Cast Iron)	
				FINISH Grey Paint	
	NEXT ASSY	USED ON			
	APPLICATION			DO NOT SCALE DRAWING	



TITLE:
2VP50-7/8

SIZE DWG. NO. REV
A 2VP50-0.875

SCALE: 1:4 WEIGHT: SHEET 1 OF 1

2

1