

2

1

B

B

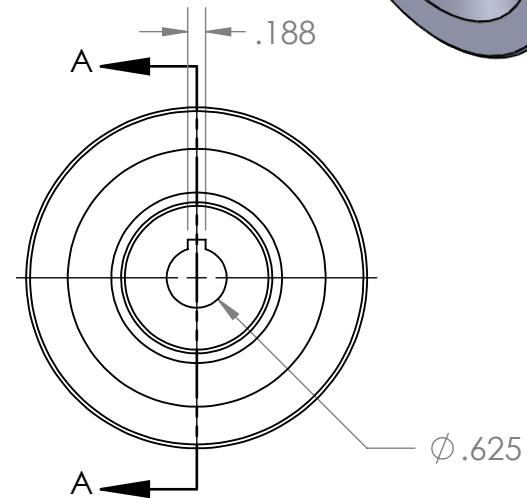
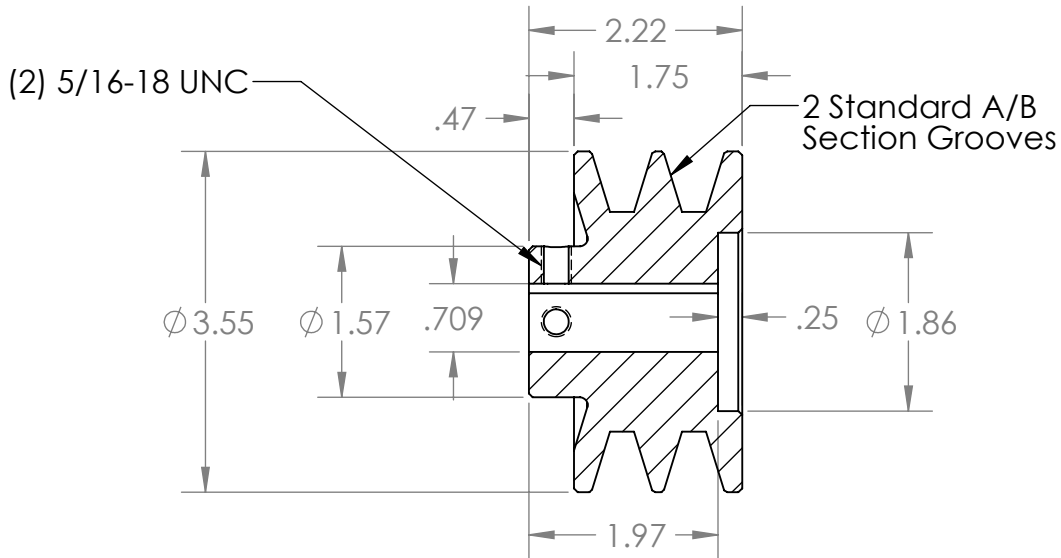
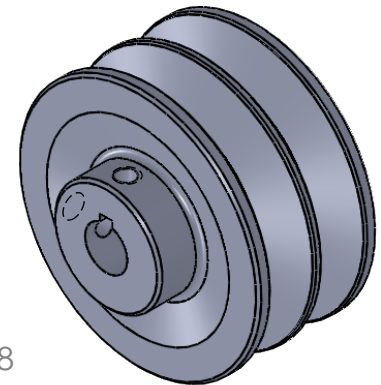

SECTION A-A

A

A

PROPRIETARY AND CONFIDENTIAL
 THE INFORMATION CONTAINED IN THIS DRAWING IS THE SOLE PROPERTY OF MASTERDRIVE, INC. ANY REPRODUCTION IN PART OR AS A WHOLE WITHOUT THE WRITTEN PERMISSION OF MASTERDRIVE, INC. IS PROHIBITED.

			NAME	DATE
			DRAWN	EDG 06/07/21
			CHECKED	
			ENG APPR.	
			MFG APPR.	
			Q.A.	
			COMMENTS:	
		INTERPRET GEOMETRIC TOLERANCING PER:		
		MATERIAL		
		HT200 (Cast Iron)		
		FINISH		
		Grey Paint		
NEXT ASSY	USED ON			
APPLICATION		DO NOT SCALE DRAWING		



TITLE:		
2BK34-5/8		
SIZE	DWG. NO.	REV
A	2BK34-0.625	
SCALE: 1:2	WEIGHT:	SHEET 1 OF 1

2

1