

2

1

B

B

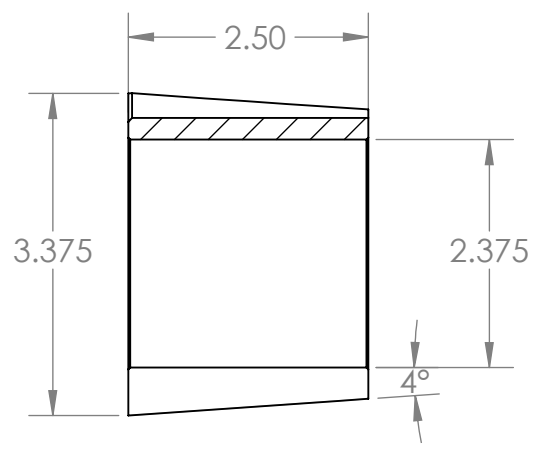
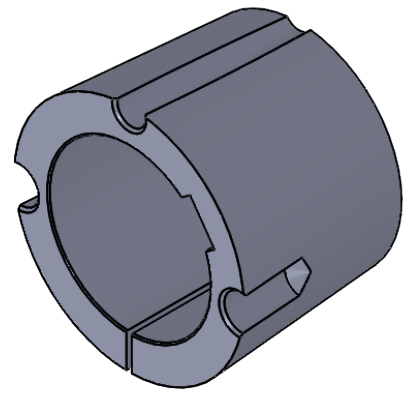

SECTION B-B

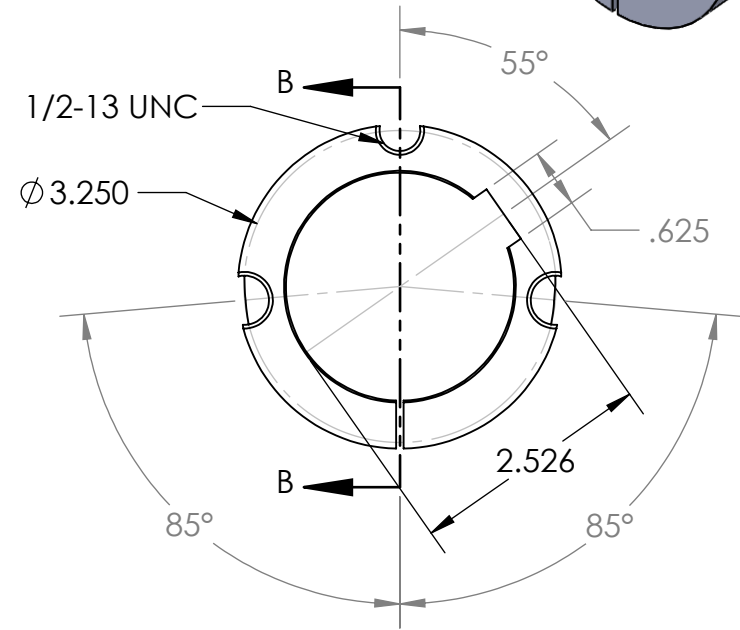

A

A

**PROPRIETARY AND CONFIDENTIAL**  
 THE INFORMATION CONTAINED IN THIS DRAWING IS THE SOLE PROPERTY OF MASTERDRIVE, INC. ANY REPRODUCTION IN PART OR AS A WHOLE WITHOUT THE WRITTEN PERMISSION OF MASTERDRIVE, INC. IS PROHIBITED.

|             |         |                                      |           |      |          |
|-------------|---------|--------------------------------------|-----------|------|----------|
|             |         |                                      |           | NAME | DATE     |
|             |         |                                      | DRAWN     | EDG  | 10/27/20 |
|             |         |                                      | CHECKED   |      |          |
|             |         |                                      | ENG APPR. |      |          |
|             |         |                                      | MFG APPR. |      |          |
|             |         |                                      | Q.A.      |      |          |
|             |         |                                      | COMMENTS: |      |          |
|             |         | INTERPRET GEOMETRIC TOLERANCING PER: |           |      |          |
|             |         | MATERIAL                             |           |      |          |
|             |         | HT200 (Cast Iron)                    |           |      |          |
|             |         | FINISH                               |           |      |          |
|             |         | Black Phosphate                      |           |      |          |
| NEXT ASSY   | USED ON |                                      |           |      |          |
| APPLICATION |         | DO NOT SCALE DRAWING                 |           |      |          |



TITLE:  
**2525-2.3/8**

SIZE DWG. NO. REV  
**A 2525-2.375**

SCALE: 1:2 WEIGHT: SHEET 1 OF 1

2

1