

2

1

B

B

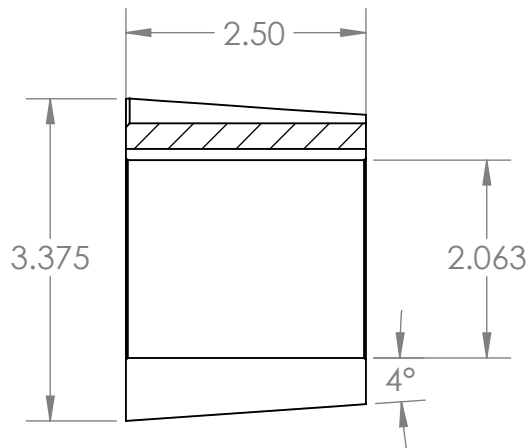
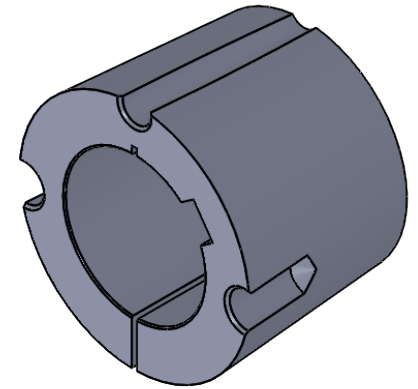

SECTION B-B

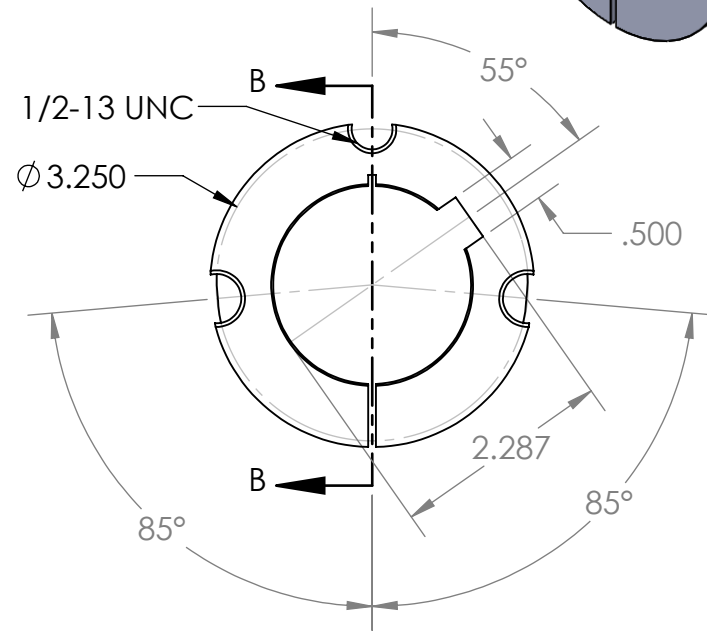

A

A

PROPRIETARY AND CONFIDENTIAL
 THE INFORMATION CONTAINED IN THIS DRAWING IS THE SOLE PROPERTY OF MASTERDRIVE, INC. ANY REPRODUCTION IN PART OR AS A WHOLE WITHOUT THE WRITTEN PERMISSION OF MASTERDRIVE, INC. IS PROHIBITED.

				NAME	DATE
			DRAWN	EDG	10/26/20
			CHECKED		
			ENG APPR.		
			MFG APPR.		
			Q.A.		
			COMMENTS:		
		INTERPRET GEOMETRIC TOLERANCING PER:			
		MATERIAL	HT200 (Cast Iron)		
		FINISH	Black Phosphate		
NEXT ASSY	USED ON				
APPLICATION		DO NOT SCALE DRAWING			



TITLE:		
2525-2.1/16		
SIZE	DWG. NO.	REV
A	2525-2.063	
SCALE: 1:2	WEIGHT:	SHEET 1 OF 1

2

1