

2

1

B

B

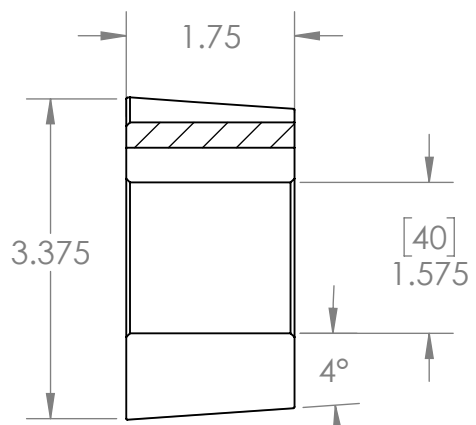
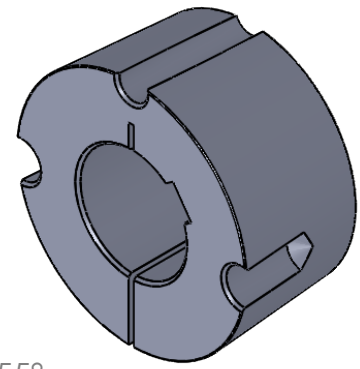

SECTION B-B

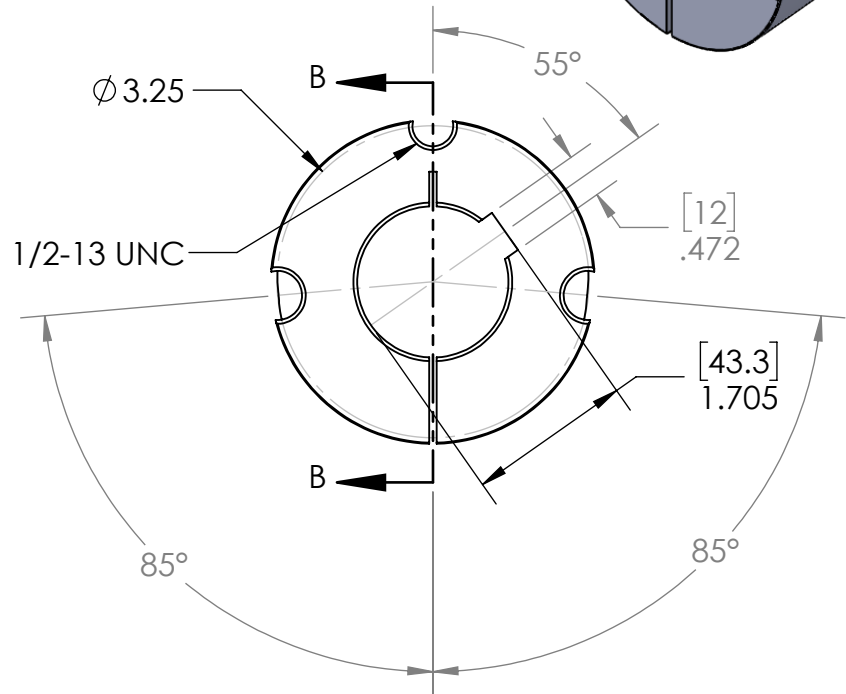

A

A

PROPRIETARY AND CONFIDENTIAL
 THE INFORMATION CONTAINED IN THIS DRAWING IS THE SOLE PROPERTY OF MASTERDRIVE, INC. ANY REPRODUCTION IN PART OR AS A WHOLE WITHOUT THE WRITTEN PERMISSION OF MASTERDRIVE, INC. IS PROHIBITED.

				NAME	DATE
			DRAWN	EDG	12/29/20
			CHECKED		
			ENG APPR.		
			MFG APPR.		
			Q.A.		
			COMMENTS:		
		INTERPRET GEOMETRIC TOLERANCING PER:			
		MATERIAL			
		HT200 (Cast Iron)			
		FINISH			
		Black Phosphate			
NEXT ASSY	USED ON				
APPLICATION		DO NOT SCALE DRAWING			



TITLE:		
2517-40MM		
SIZE	DWG. NO.	REV
A	2517-40MM	
SCALE: 1:2	WEIGHT:	SHEET 1 OF 1

2

1