

2

1

B

B

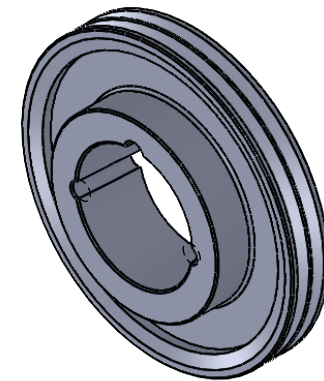
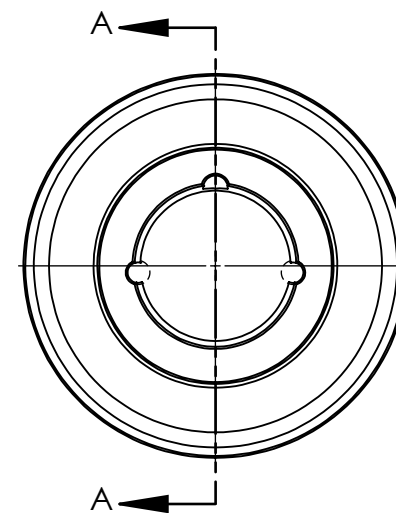
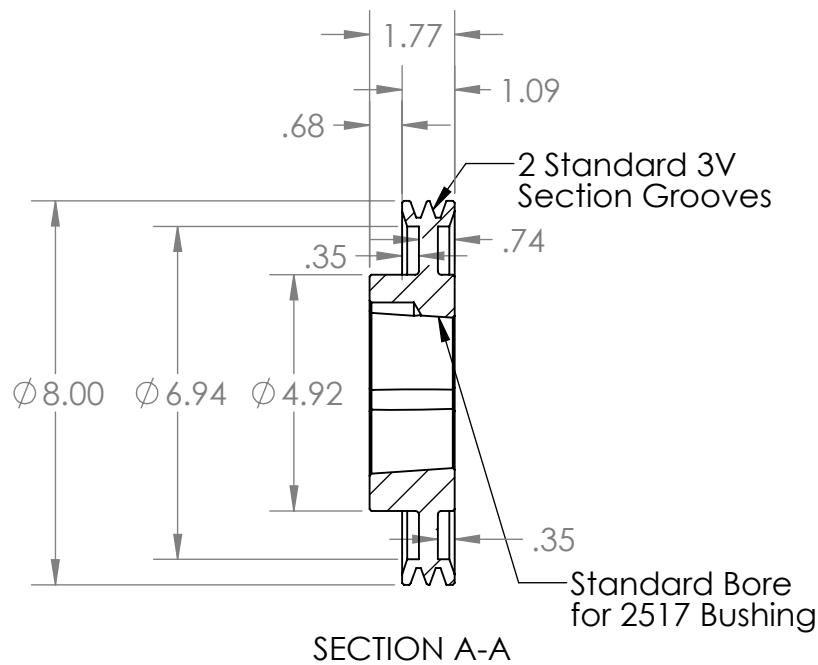

A

A

**PROPRIETARY AND CONFIDENTIAL**  
 THE INFORMATION CONTAINED IN THIS DRAWING IS THE SOLE PROPERTY OF MASTERDRIVE, INC. ANY REPRODUCTION IN PART OR AS A WHOLE WITHOUT THE WRITTEN PERMISSION OF MASTERDRIVE, INC. IS PROHIBITED.

			INTERPRET GEOMETRIC TOLERANCING PER:
			MATERIAL HT200 (Cast Iron)
			FINISH Grey Paint
NEXT ASSY	USED ON		
APPLICATION			DO NOT SCALE DRAWING

	NAME	DATE
DRAWN	EDG	09/13/21
CHECKED		
ENG APPR.		
MFG APPR.		
Q.A.		
COMMENTS:		



TITLE:  
**2/3V800-2517**

SIZE	DWG. NO.	REV
<b>A</b>	<b>23V800-2517</b>	
SCALE: 1:4	WEIGHT:	SHEET 1 OF 1

2

1