

2

1

B

B

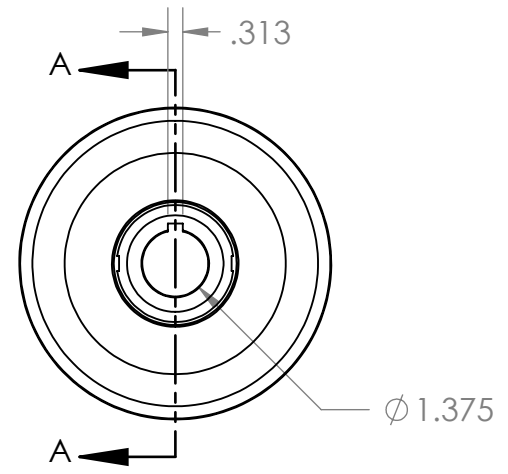
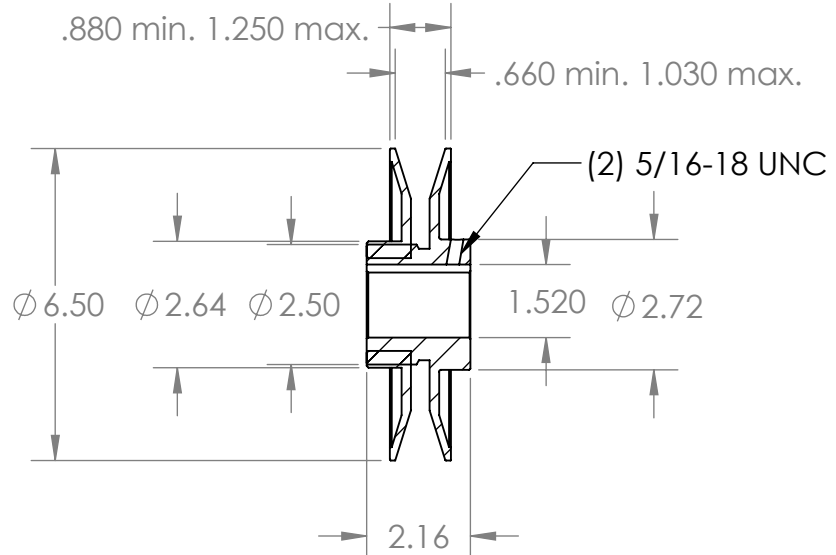
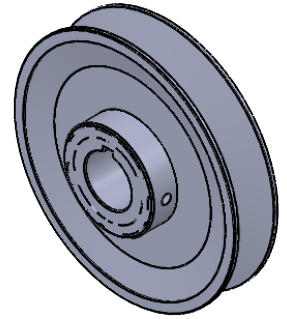

SECTION A-A

A

A

PROPRIETARY AND CONFIDENTIAL
 THE INFORMATION CONTAINED IN THIS DRAWING IS THE SOLE PROPERTY OF MASTERDRIVE, INC. ANY REPRODUCTION IN PART OR AS A WHOLE WITHOUT THE WRITTEN PERMISSION OF MASTERDRIVE, INC. IS PROHIBITED.

				NAME	DATE
				EDG	07/27/21
				CHECKED	
				ENG APPR.	
				MFG APPR.	
				Q.A.	
				COMMENTS:	
			INTERPRET GEOMETRIC TOLERANCING PER:		
			MATERIAL		
			HT200 (Cast Iron)		
			FINISH		
			Grey Paint		
NEXT ASSY	USED ON				
APPLICATION			DO NOT SCALE DRAWING		



TITLE:
1VP65-1-3/8

SIZE DWG. NO. REV
A 1VP65-1.375

SCALE: 1:4 WEIGHT: SHEET 1 OF 1

2

1