

2

1

B

B

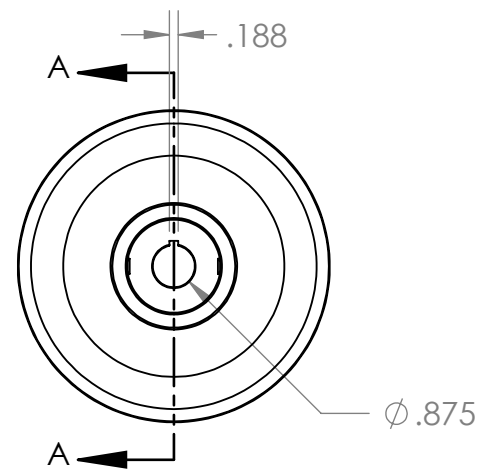
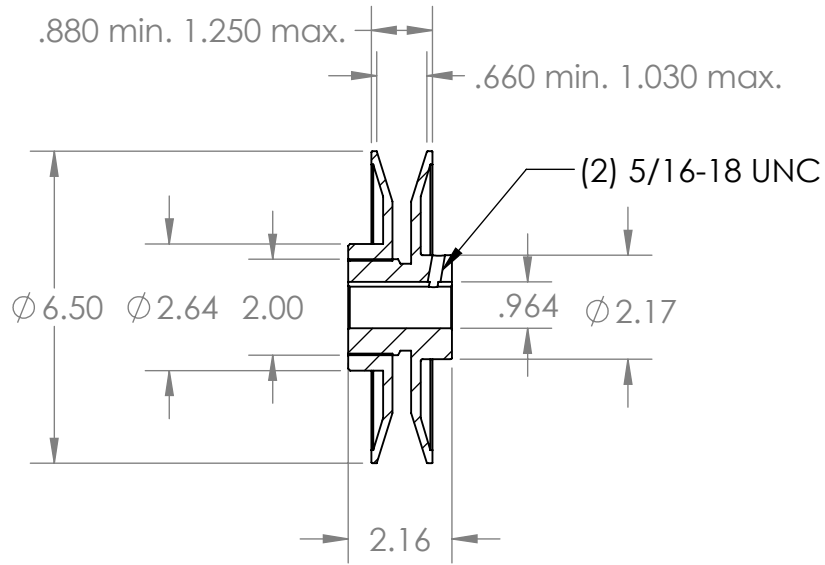
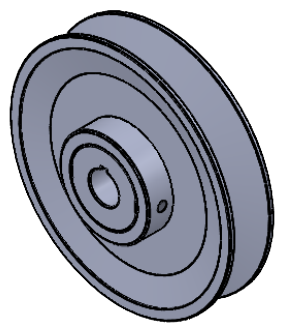

SECTION A-A

A

A

PROPRIETARY AND CONFIDENTIAL
 THE INFORMATION CONTAINED IN THIS DRAWING IS THE SOLE PROPERTY OF MASTERDRIVE, INC. ANY REPRODUCTION IN PART OR AS A WHOLE WITHOUT THE WRITTEN PERMISSION OF MASTERDRIVE, INC. IS PROHIBITED.

				NAME	DATE
				DRAWN	EDG 07/27/21
				CHECKED	
				ENG APPR.	
				MFG APPR.	
				Q.A.	
				COMMENTS:	
			INTERPRET GEOMETRIC TOLERANCING PER:		
			MATERIAL		
			HT200 (Cast Iron)		
			FINISH		
			Grey Paint		
	NEXT ASSY	USED ON			
	APPLICATION		DO NOT SCALE DRAWING		



TITLE:
1VP65-7/8

SIZE	DWG. NO.	REV
A	1VP65-0.875	
SCALE: 1:4	WEIGHT:	SHEET 1 OF 1

2

1