

2

1

B

B

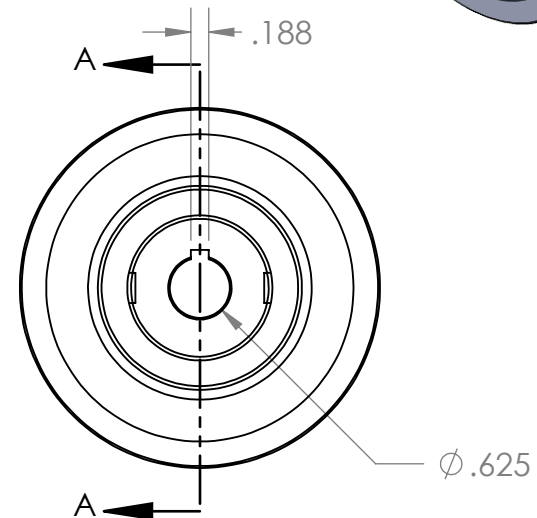
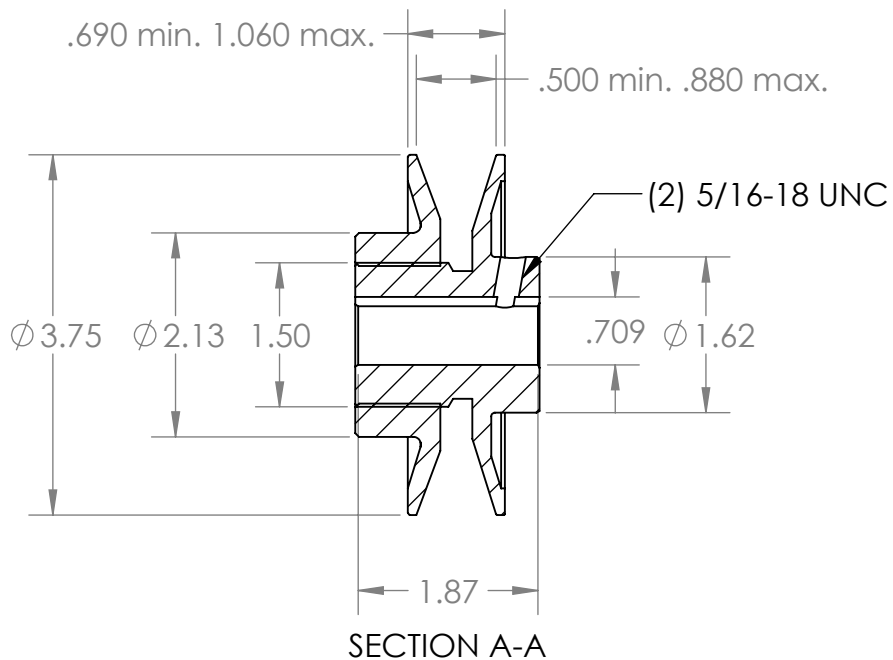
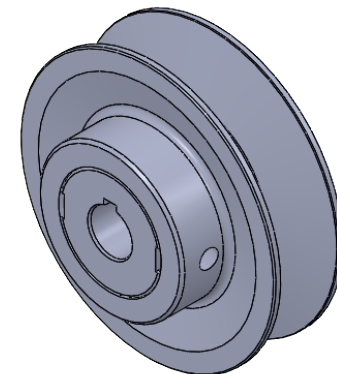

A

A

PROPRIETARY AND CONFIDENTIAL
 THE INFORMATION CONTAINED IN THIS DRAWING IS THE SOLE PROPERTY OF MASTERDRIVE, INC. ANY REPRODUCTION IN PART OR AS A WHOLE WITHOUT THE WRITTEN PERMISSION OF MASTERDRIVE, INC. IS PROHIBITED.

				NAME	DATE
				DRAWN	EDG 07/19/21
				CHECKED	
				ENG APPR.	
				MFG APPR.	
				Q.A.	
				COMMENTS:	
				INTERPRET GEOMETRIC TOLERANCING PER:	
				MATERIAL HT200 (Cast Iron)	
				FINISH Grey Paint	
	NEXT ASSY	USED ON			
	APPLICATION			DO NOT SCALE DRAWING	



TITLE:		
1VP40-5/8		
SIZE	DWG. NO.	REV
A	1VP40-0.625	
SCALE: 1:2	WEIGHT:	SHEET 1 OF 1

2

1