

2

1

B

B

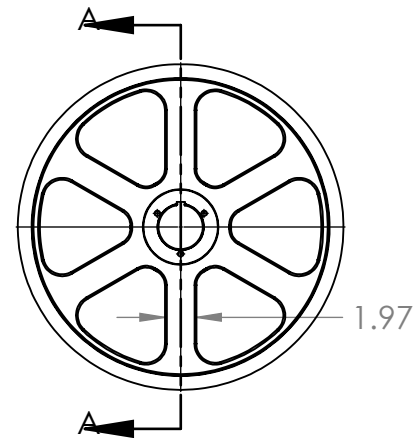
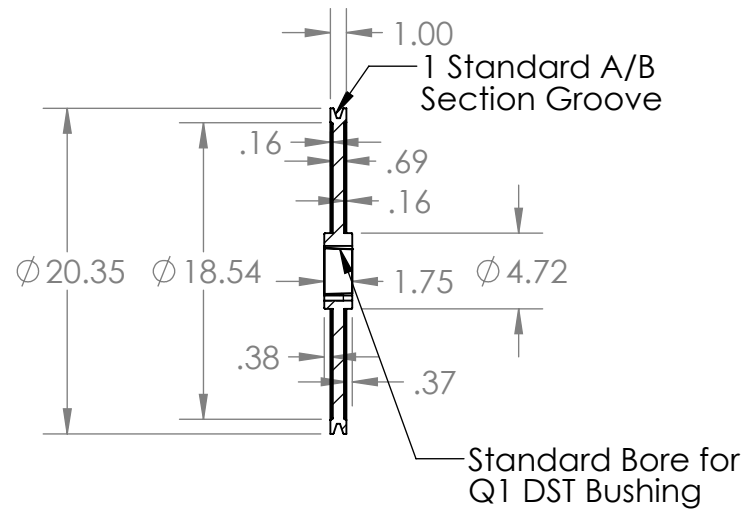
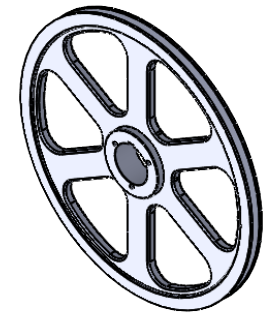

SECTION A-A

A

A

PROPRIETARY AND CONFIDENTIAL
 THE INFORMATION CONTAINED IN THIS DRAWING IS THE SOLE PROPERTY OF MASTERDRIVE, INC. ANY REPRODUCTION IN PART OR AS A WHOLE WITHOUT THE WRITTEN PERMISSION OF MASTERDRIVE, INC. IS PROHIBITED.

		INTERPRET GEOMETRIC TOLERANCING PER:	
		MATERIAL	HT200 (Cast Iron)
		FINISH	Grey Paint
NEXT ASSY	USED ON		
APPLICATION		DO NOT SCALE DRAWING	

	NAME	DATE
DRAWN	EDG	08/19/21
CHECKED		
ENG APPR.		
MFG APPR.		
Q.A.		
COMMENTS:		



TITLE:		
1B200Q1		
SIZE	DWG. NO.	REV
A	1B200Q1	
SCALE: 1:12	WEIGHT:	SHEET 1 OF 1

2

1