

2

1

B

B

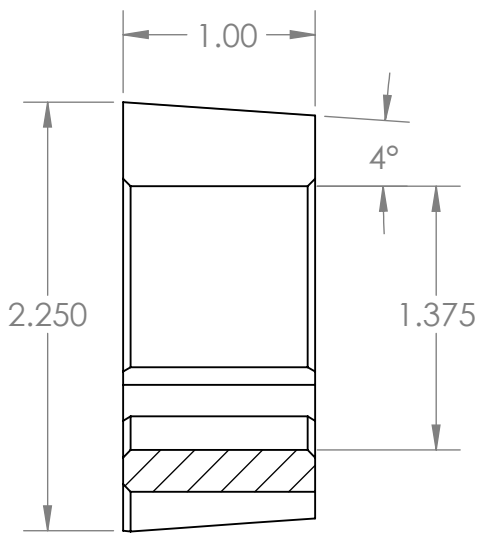
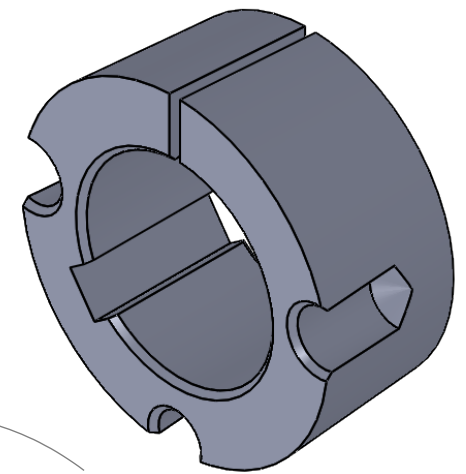

SECTION B-B

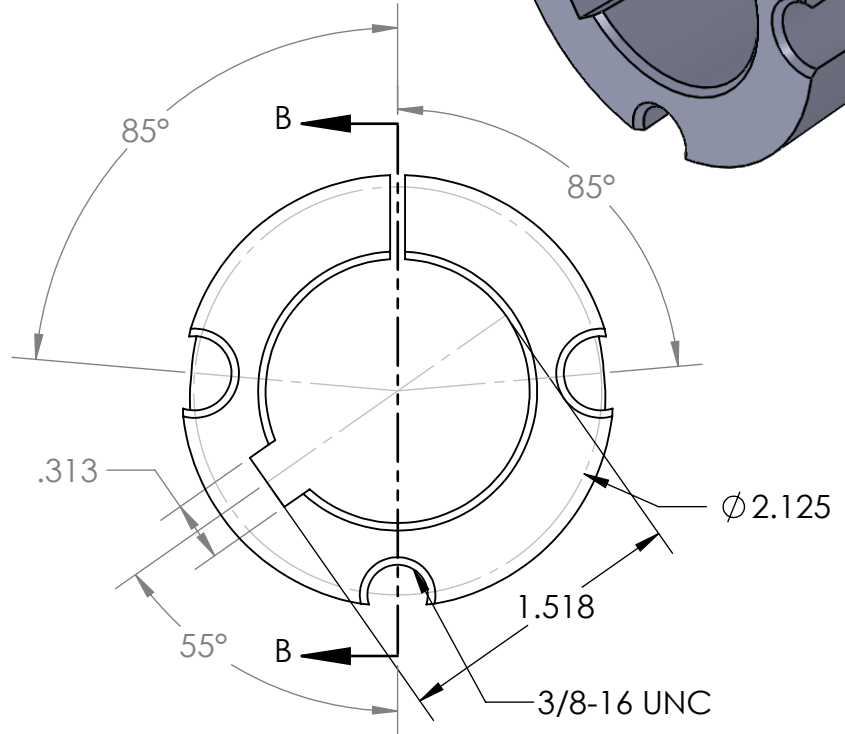

A

A

**PROPRIETARY AND CONFIDENTIAL**  
 THE INFORMATION CONTAINED IN THIS DRAWING IS THE SOLE PROPERTY OF MASTERDRIVE, INC. ANY REPRODUCTION IN PART OR AS A WHOLE WITHOUT THE WRITTEN PERMISSION OF MASTERDRIVE, INC. IS PROHIBITED.

			NAME	DATE
			DRAWN	EDG 09/28/20
			CHECKED	
			ENG APPR.	
			MFG APPR.	
			Q.A.	
			COMMENTS:	
		INTERPRET GEOMETRIC TOLERANCING PER:		
		MATERIAL		
		HT200 (Cast Iron)		
		FINISH		
		Black Phosphate		
NEXT ASSY	USED ON			
APPLICATION		DO NOT SCALE DRAWING		



TITLE:		
1610-1.3/8		
SIZE	DWG. NO.	REV
<b>A</b>	1610-1.375	
SCALE: 1:1	WEIGHT:	SHEET 1 OF 1

2

1