

2

1

B

B

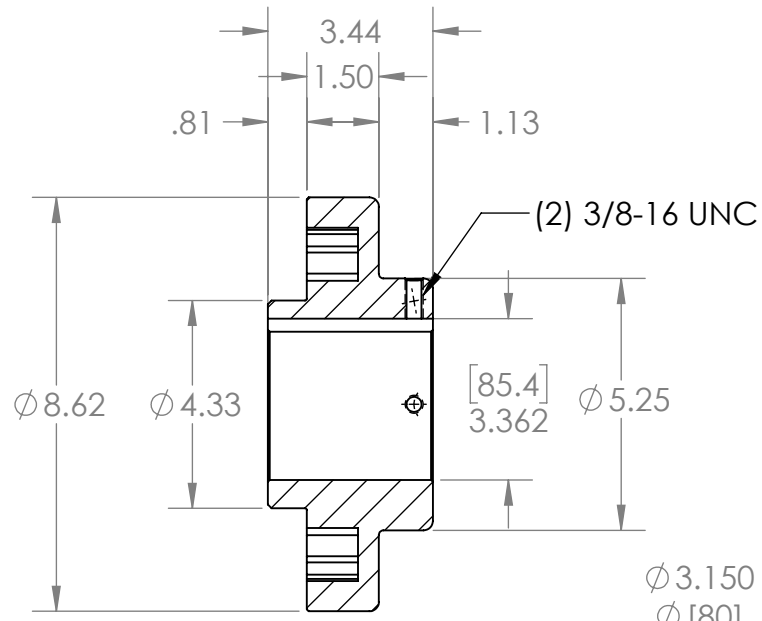
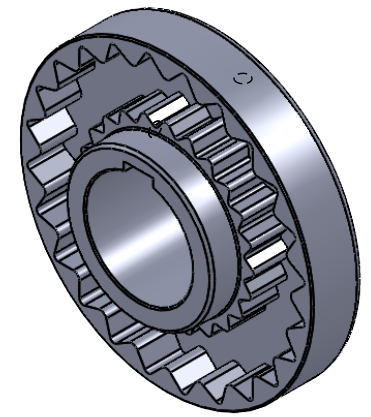

SECTION A-A

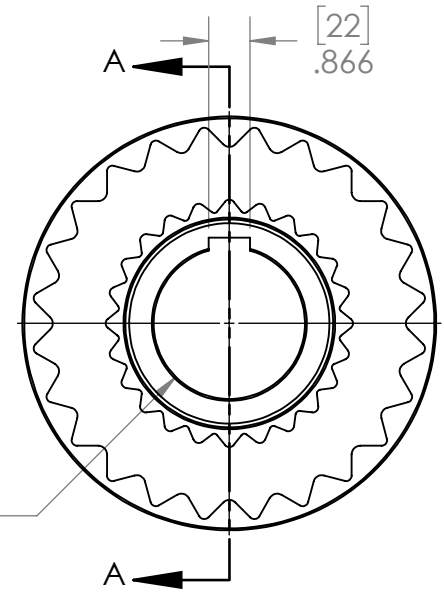

A

A

PROPRIETARY AND CONFIDENTIAL
 THE INFORMATION CONTAINED IN THIS DRAWING IS THE SOLE PROPERTY OF MASTERDRIVE, INC. ANY REPRODUCTION IN PART OR AS A WHOLE WITHOUT THE WRITTEN PERMISSION OF MASTERDRIVE, INC. IS PROHIBITED.

				NAME	DATE
				EDG	08/08/23
				CHECKED	
				ENG APPR.	
				MFG APPR.	
				Q.A.	
				COMMENTS:	
		INTERPRET GEOMETRIC TOLERANCING PER:			
		MATERIAL	HT200 (Cast Iron)		
		FINISH	Grey Paint		
NEXT ASSY	USED ON				
APPLICATION		DO NOT SCALE DRAWING			



TITLE:
11S-80MM

SIZE **A** DWG. NO. **11S-80MM** REV

SCALE: 1:4 WEIGHT: SHEET 1 OF 1

2

1