

2

1

B

B

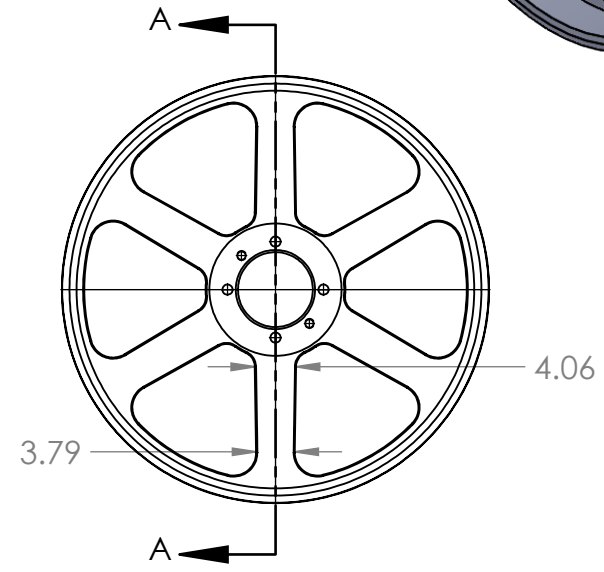
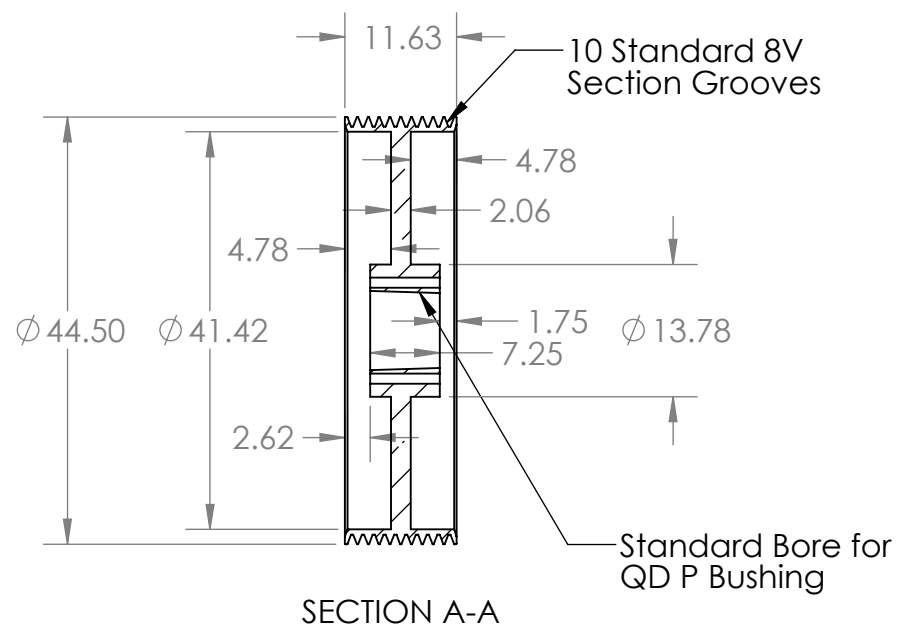
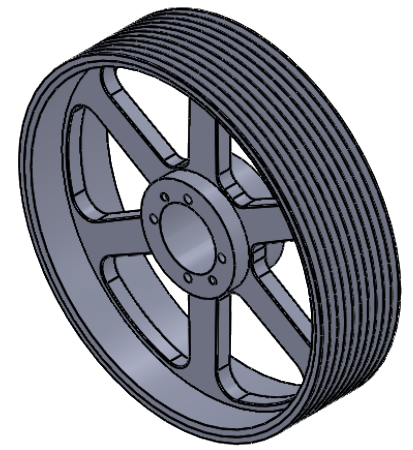

A

A

**PROPRIETARY AND CONFIDENTIAL**  
 THE INFORMATION CONTAINED IN THIS DRAWING IS THE SOLE PROPERTY OF <INSERT COMPANY NAME HERE>. ANY REPRODUCTION IN PART OR AS A WHOLE WITHOUT THE WRITTEN PERMISSION OF <INSERT COMPANY NAME HERE> IS PROHIBITED.

			NAME	DATE
			DRAWN	EDG 07/15/20
			CHECKED	
			ENG APPR.	
			MFG APPR.	
			Q.A.	
			COMMENTS:	
		INTERPRET GEOMETRIC TOLERANCING PER:		
		MATERIAL	HT200 (Cast Iron)	
		FINISH	Grey Paint	
NEXT ASSY	USED ON			
APPLICATION		DO NOT SCALE DRAWING		



TITLE:  
**10/8V4450P**

SIZE DWG. NO. REV  
**A 108V4450P**

SCALE: 1:20 WEIGHT: SHEET 1 OF 1

2

1