

9 8 7 6 5 4 3 2 1

G
F
E
D
C
B
A

G
F
E
D
C
B
A

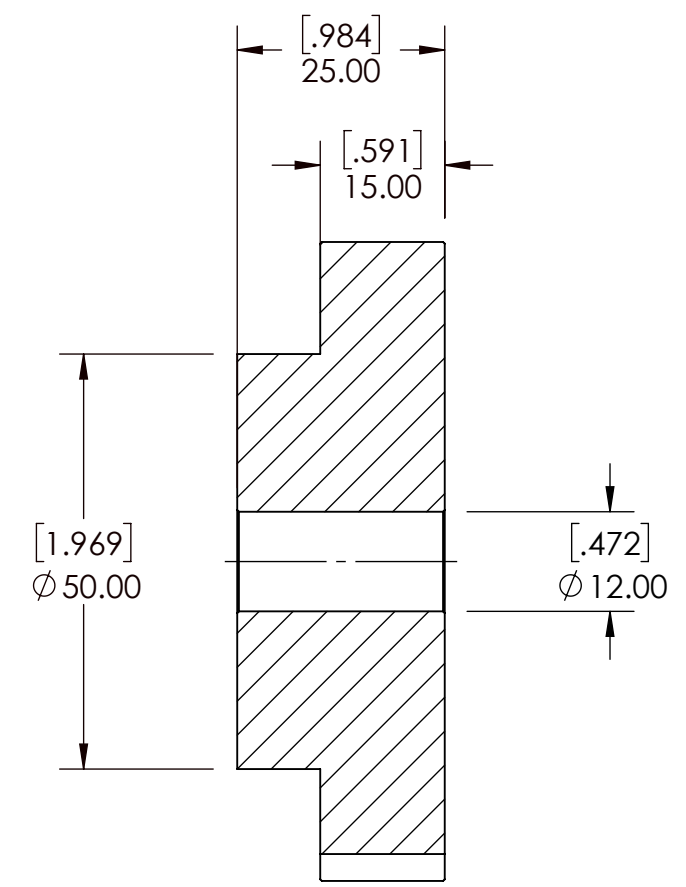
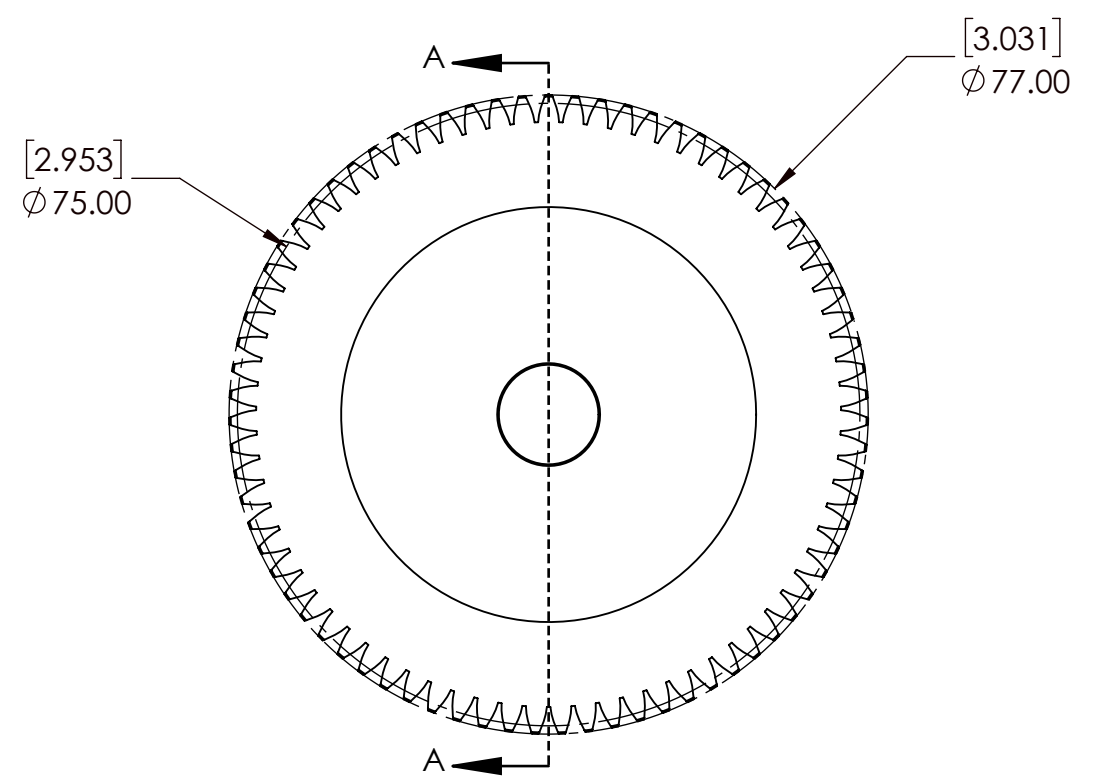
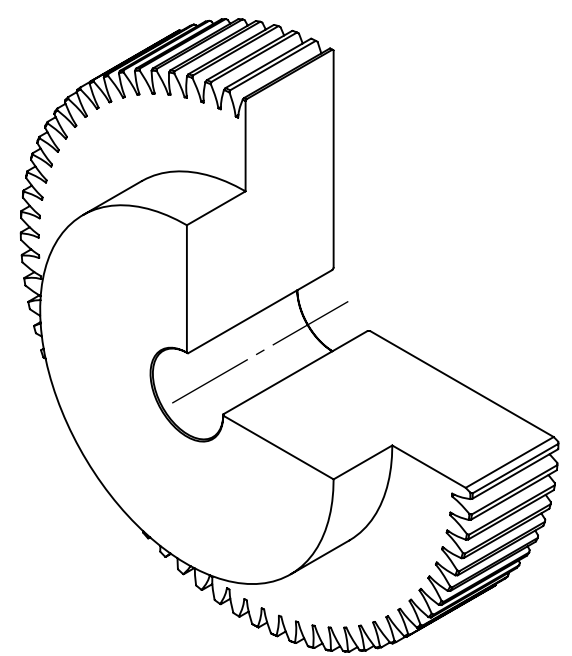

SECTION A-A

SPUR GEAR SPECIFICATIONS		WEIGHT		DATE		BY		REVISION DESCRIPTION		REV
UNITS	mm (INCH)	1.41 LBS								
MODULE	1	STEEL								
PRESSURE ANGLE	20°	N/A								
NUMBER OF TEETH	75	DRAWN SEC 08/28/2025								
PITCH DIAMETER	75mm	CHECKED SEC 08/28/2025								
HUB TYPE	B	APPROVED								
MAX TORQUE (Nm)	18.38 Nm	THIRD ANGLE PROJECTION								
TOOTH TYPE	STRAIGHT	DWG. NO.								
MAX RIM SPEED	12 M/S	PTI								
		PROPRIETARY AND CONFIDENTIAL								
		THE INFORMATION CONTAINED IN THIS DRAWING IS THE SOLE PROPERTY OF SOLVE IMG. ANY REPRODUCTION IN PART OR AS A WHOLE WITHOUT THE WRITTEN PERMISSION OF SOLVE IMG IS PROHIBITED.								
		M1B75								
		SCALE 1:1								
		REV -								

9 8 7 6 5 4 3 2 1