

9 8 7 6 5 4 3 2 1

G
F
E
D
C
B
A

G
F
E
D
C
B
A

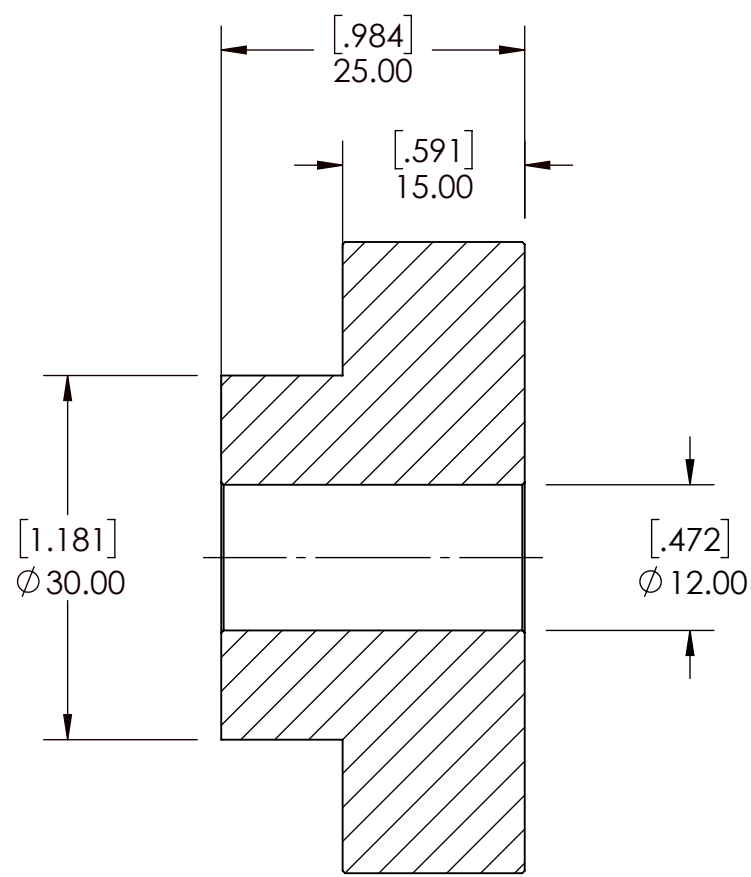
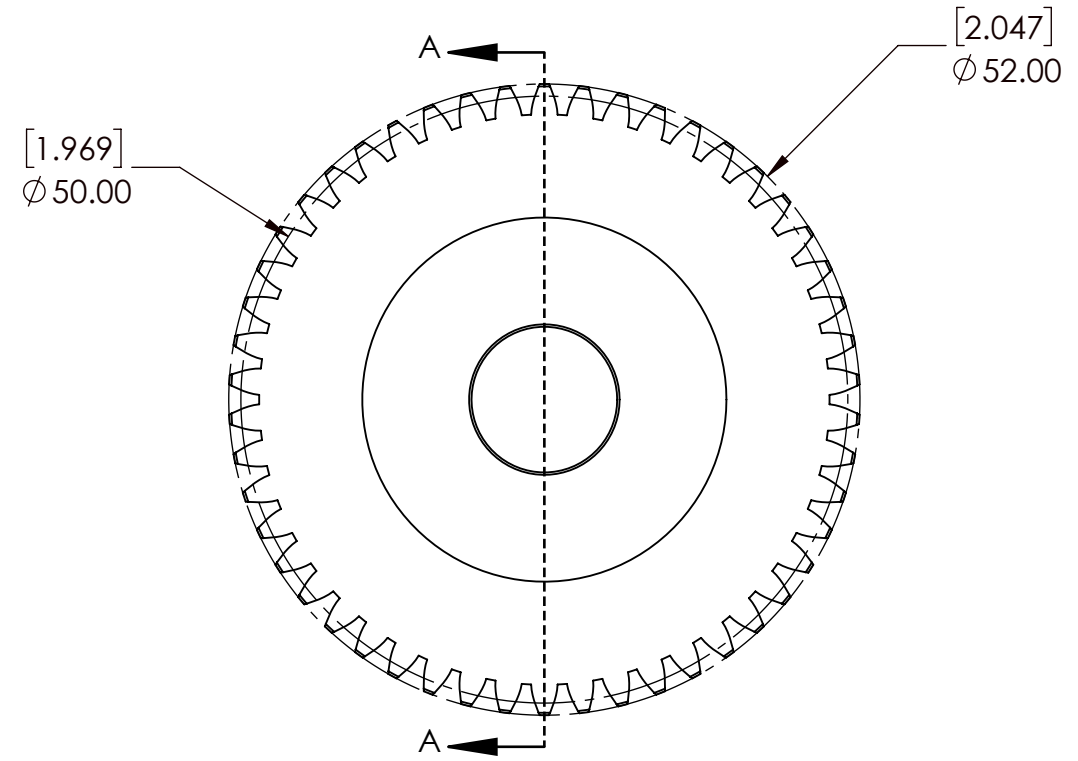
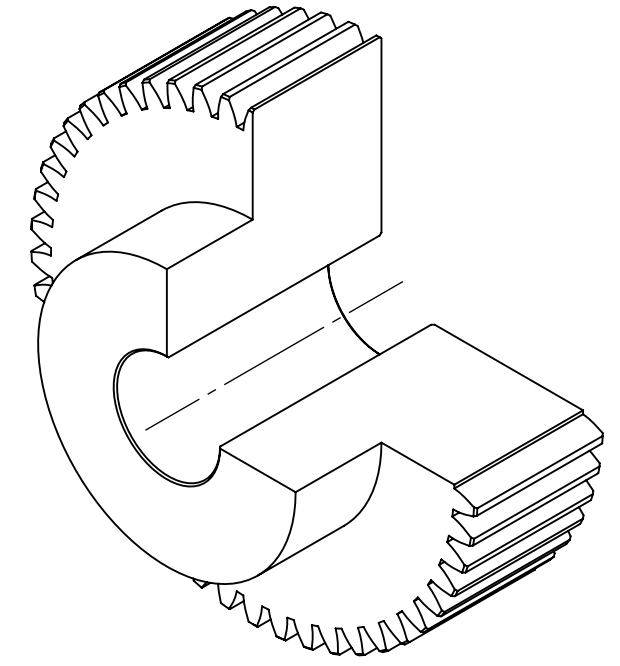

SECTION A-A

SPUR GEAR SPECIFICATIONS		WEIGHT		DATE		BY		REVISION DESCRIPTION		REV
UNITS	mm (INCH)	0.57 LBS								
MODULE	1	STEEL								
PRESSURE ANGLE	20°	N/A								
NUMBER OF TEETH	50	DRAWN	SEC	08/28/2025						
PITCH DIAMETER	50mm	CHECKED	SEC	08/28/2025						
HUB TYPE	B	APPROVED								
MAX TORQUE (Nm)	7.25 Nm					ITEM DESCRIPTION:		M1B50		SCALE
TOOTH TYPE	STRAIGHT									DWG. NO.
MAX RIM SPEED	12 M/S									REV
										-

9 8 7 6 5 4 3 2 1