

SECTION VIEW A-A

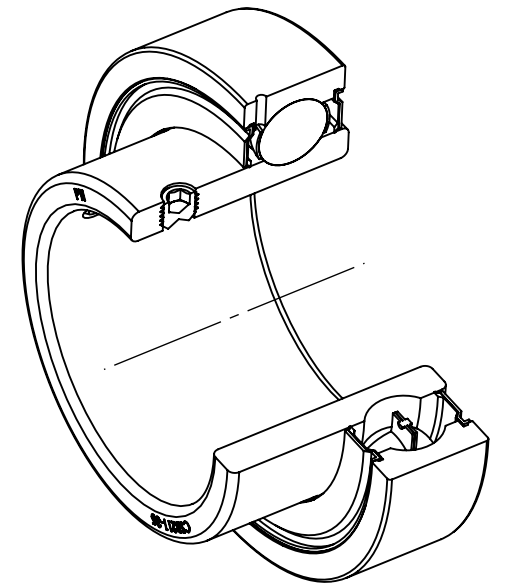

SPECIFICATIONS	
UNITS:	IN (mm)
LOAD RATINGS	C: 9,780 LBS Co: 6,580 LBS
SPEED RATING	3100 RPM
GREASE TYPE	NLGI #2
GREASE FILL	40%
OPERATING TEMP	10°F - 200°F
SEAL TYPE	K-TYPE
INTERNAL CLEARANCE	C3
TORQUE SETTING ON SET SCREWS	



WEIGHT	1.84 LBS
MATERIAL	BEARING STEEL
COATING	N/A
DRAWN	SEC 01/16/2025
CHECKED	SEC 01/16/2025
APPROVED	
THIRD ANGLE PROJECTION	

DATE	BY	REVISION DESCRIPTION	REV
ITEM DESCRIPTION:			SCALE
CSB211-35			1:11
			REV
			-

9 8 7 6 5 4 3 2 1

9 8 7 6 5 4 3 2 1

G
F
E
D
C
B
A

G
F
E
D
C
B
A