

9 8 7 6 5 4 3 2 1

G
F
E
D
C
B
A

G
F
E
D
C
B
A

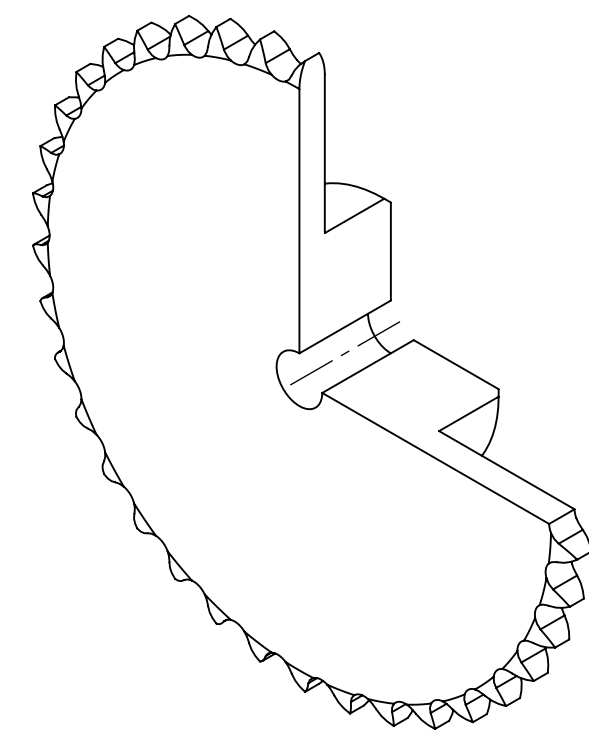
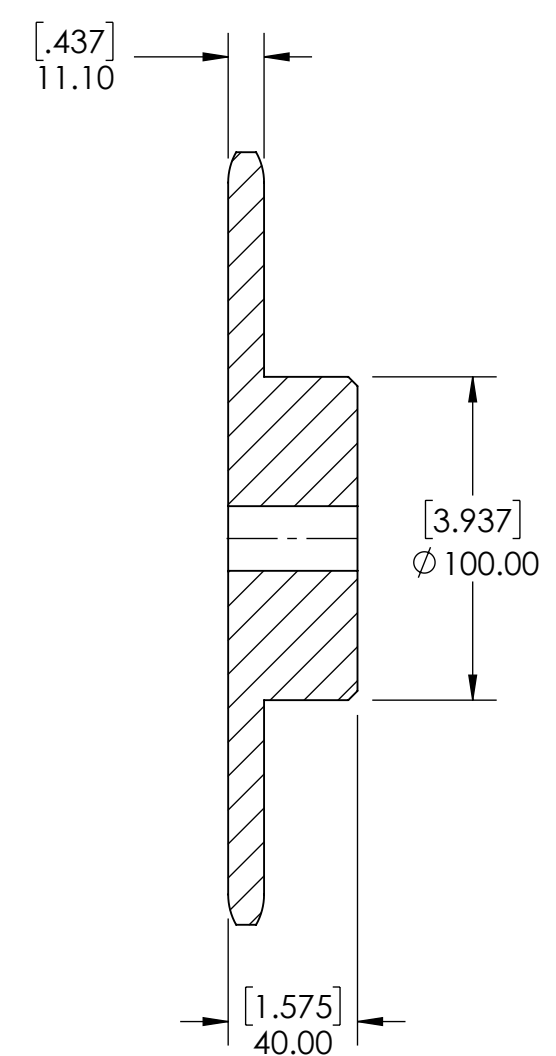
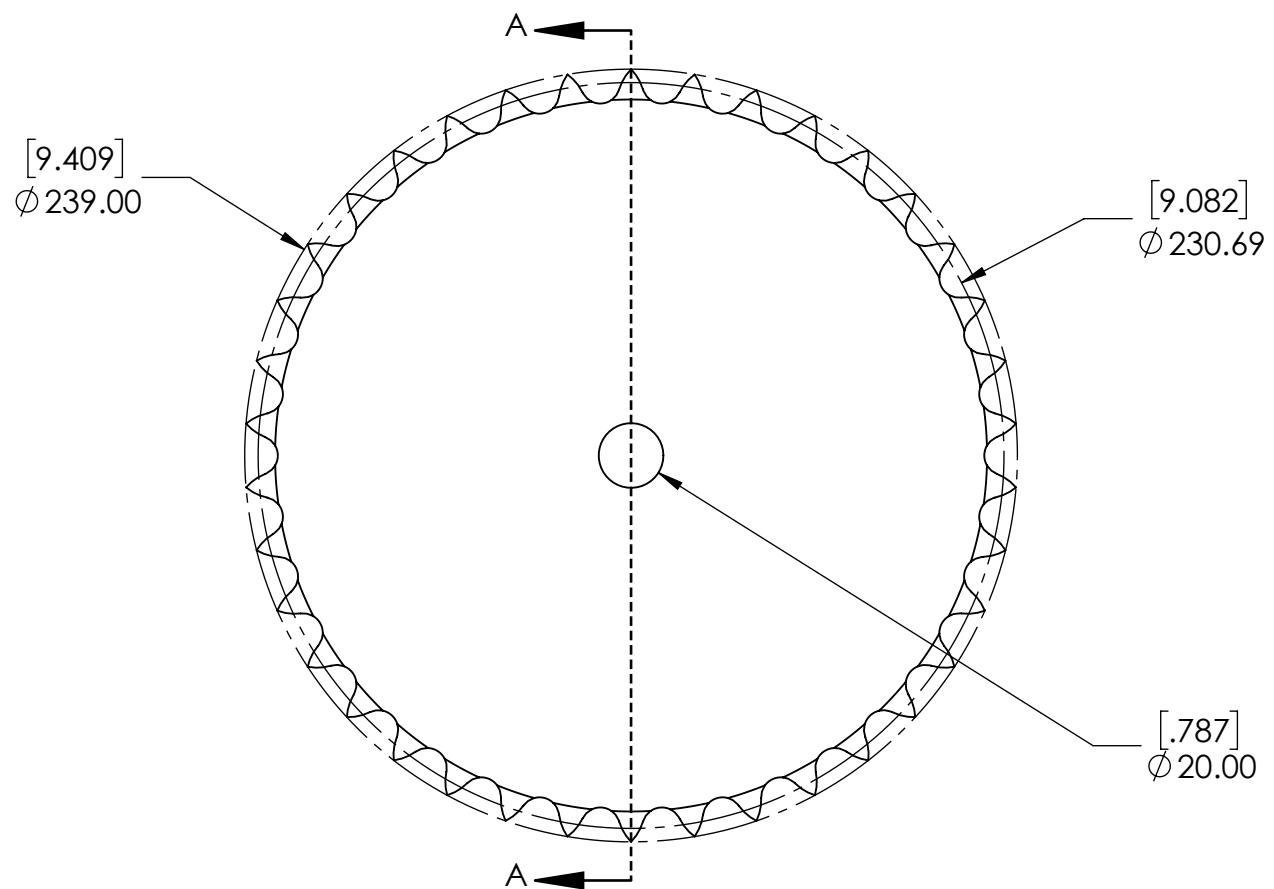

SECTION A-A

SPROCKETS SPECIFICATIONS		WEIGHT		11.36 LBS	
UNITS	mm (INCH)	MATERIAL	STEEL		
CHAIN SIZE	12B	COATING	BLACK OXIDE		
PITCH	19.05 mm	DRAWN	SEC	07/21/2025	
INNER WIDTH	11.68 mm	CHECKED	DH	08/14/2025	
ROLLER DIA.	12.07 mm	APPROVED	DATE BY REVISION DESCRIPTION		
TOOTH WIDTH	11.10 mm		ITEM DESCRIPTION:		
NUMBER OF TEETH	38		12B-38B		
HUB STYLE	B	DWG. NO.		SCALE	
BORE TYPE	PLAIN BORE	PROPRIETARY AND CONFIDENTIAL		1:1	
BUSHING NUMBER	N/A	THE INFORMATION CONTAINED IN THIS DRAWING IS THE SOLE PROPERTY OF SOLVE IMG. ANY REPRODUCTION IN PART OR AS A WHOLE WITHOUT THE WRITTEN PERMISSION OF SOLVE IMG IS PROHIBITED.		REV	
					-

9 8 7 6 5 4 3 2 1