

9 8 7 6 5 4 3 2 1

G
F
E
D
C
B
A

G
F
E
D
C
B
A

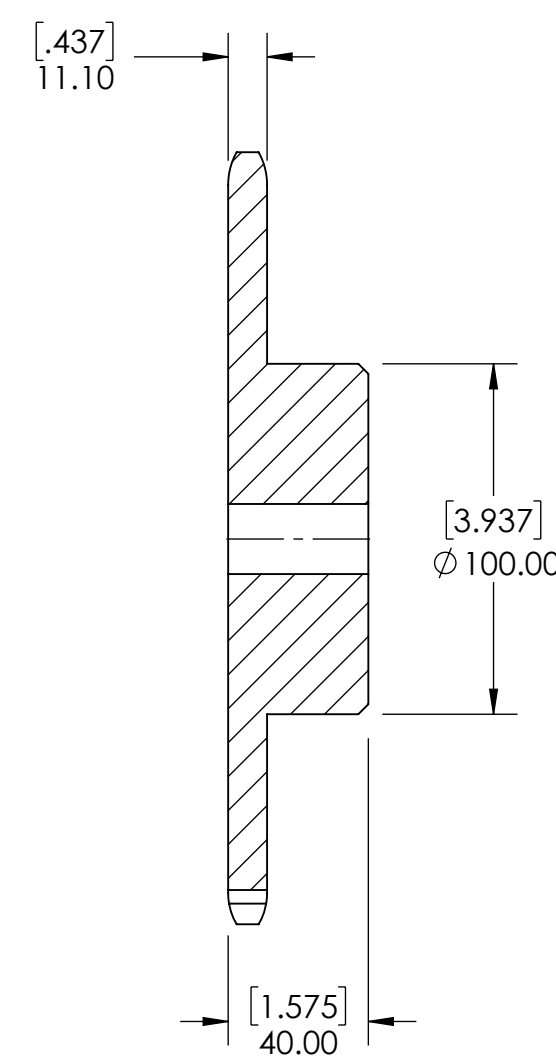
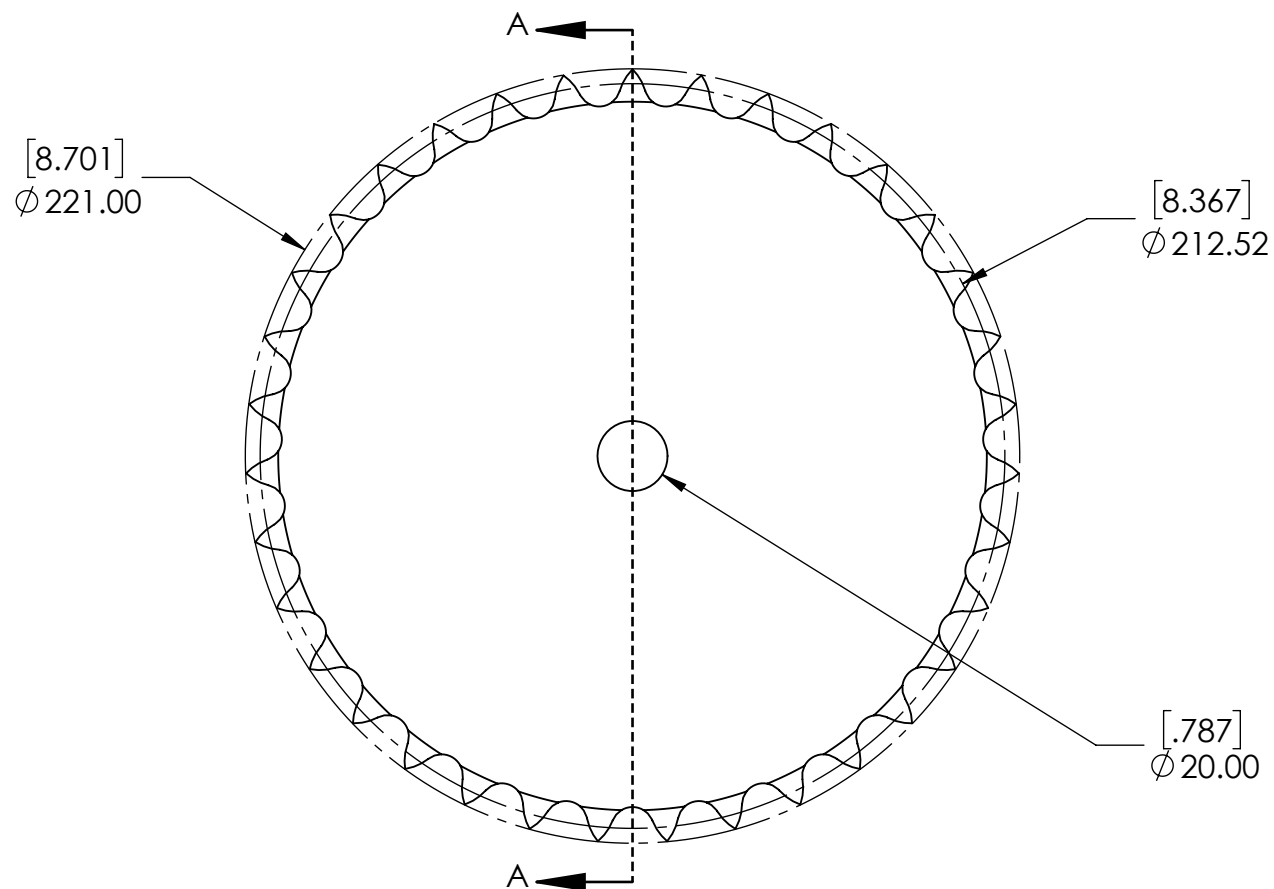

SECTION A-A

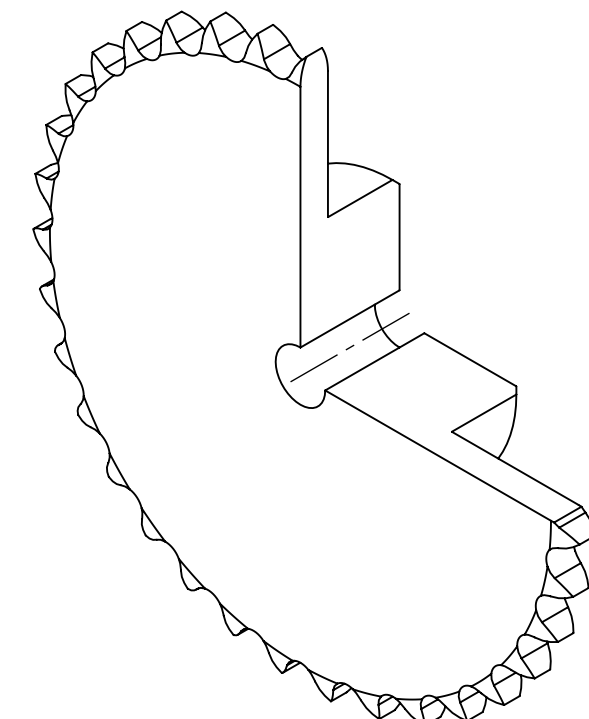

SPROCKETS SPECIFICATIONS		WEIGHT		DATE		BY		REVISION DESCRIPTION		REV
UNITS	mm (INCH)	10.17 LBS								
CHAIN SIZE	12B	MATERIAL	STEEL							
PITCH	19.05 mm	COATING	BLACK OXIDE							
INNER WIDTH	11.68 mm	DRAWN	SEC	08/18/2025						
ROLLER DIA.	12.07 mm	CHECKED	DH	08/18/2025						
TOOTH WIDTH	11.10 mm	APPROVED								
NUMBER OF TEETH	35	THIRD ANGLE PROJECTION								
HUB STYLE	B	DWG. NO.								
BORE TYPE	PLAIN BORE	PTI								
BUSHING NUMBER	N/A	PROPRIETARY AND CONFIDENTIAL								
		THE INFORMATION CONTAINED IN THIS DRAWING IS THE SOLE PROPERTY OF SOLVE IMG. ANY REPRODUCTION IN PART OR AS A WHOLE WITHOUT THE WRITTEN PERMISSION OF SOLVE IMG IS PROHIBITED.								
		ITEM DESCRIPTION:								
		12B-35B								
		SCALE								
		1:1								
		REV								
		-								

9 8 7 6 5 4 3 2 1