

9 8 7 6 5 4 3 2 1

G
F
E
D
C
B
A

G
F
E
D
C
B
A

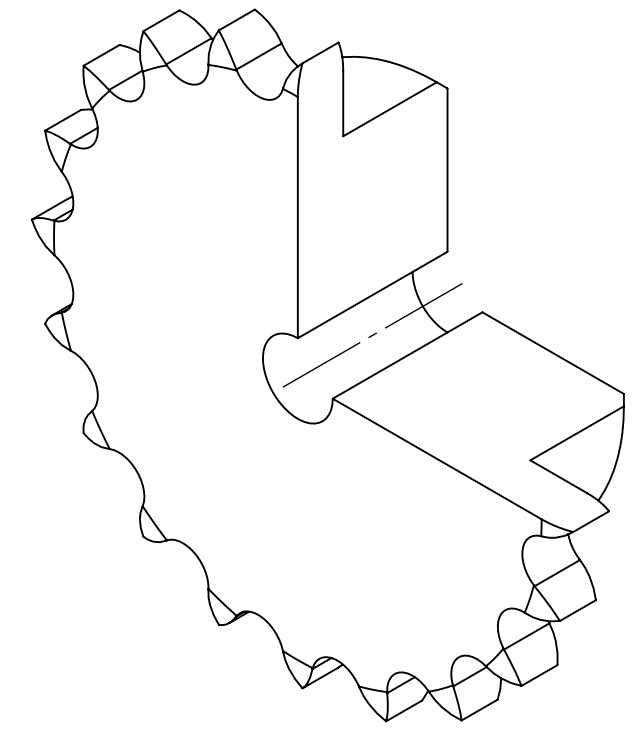
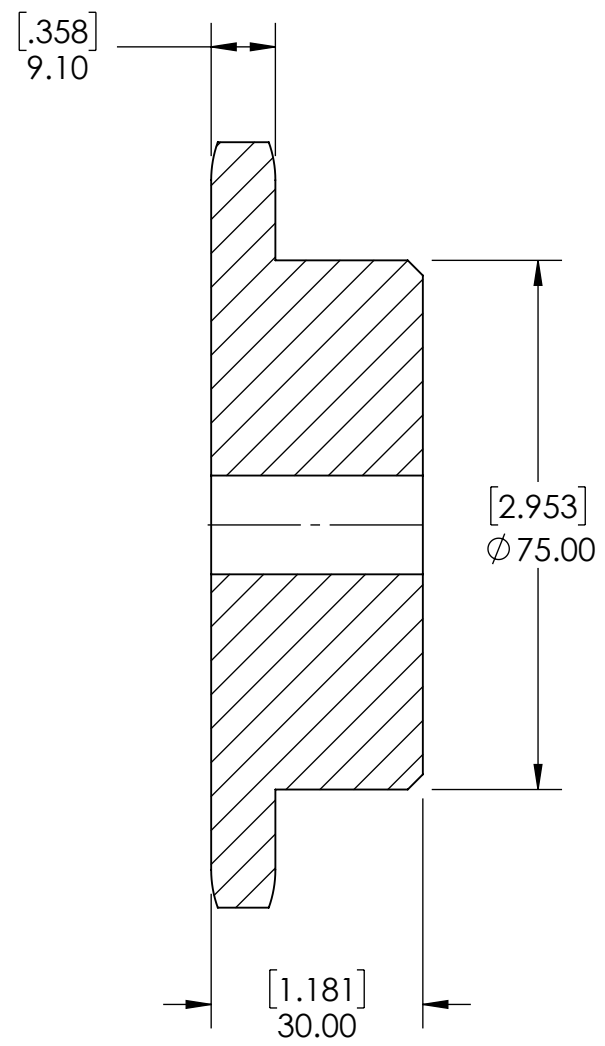
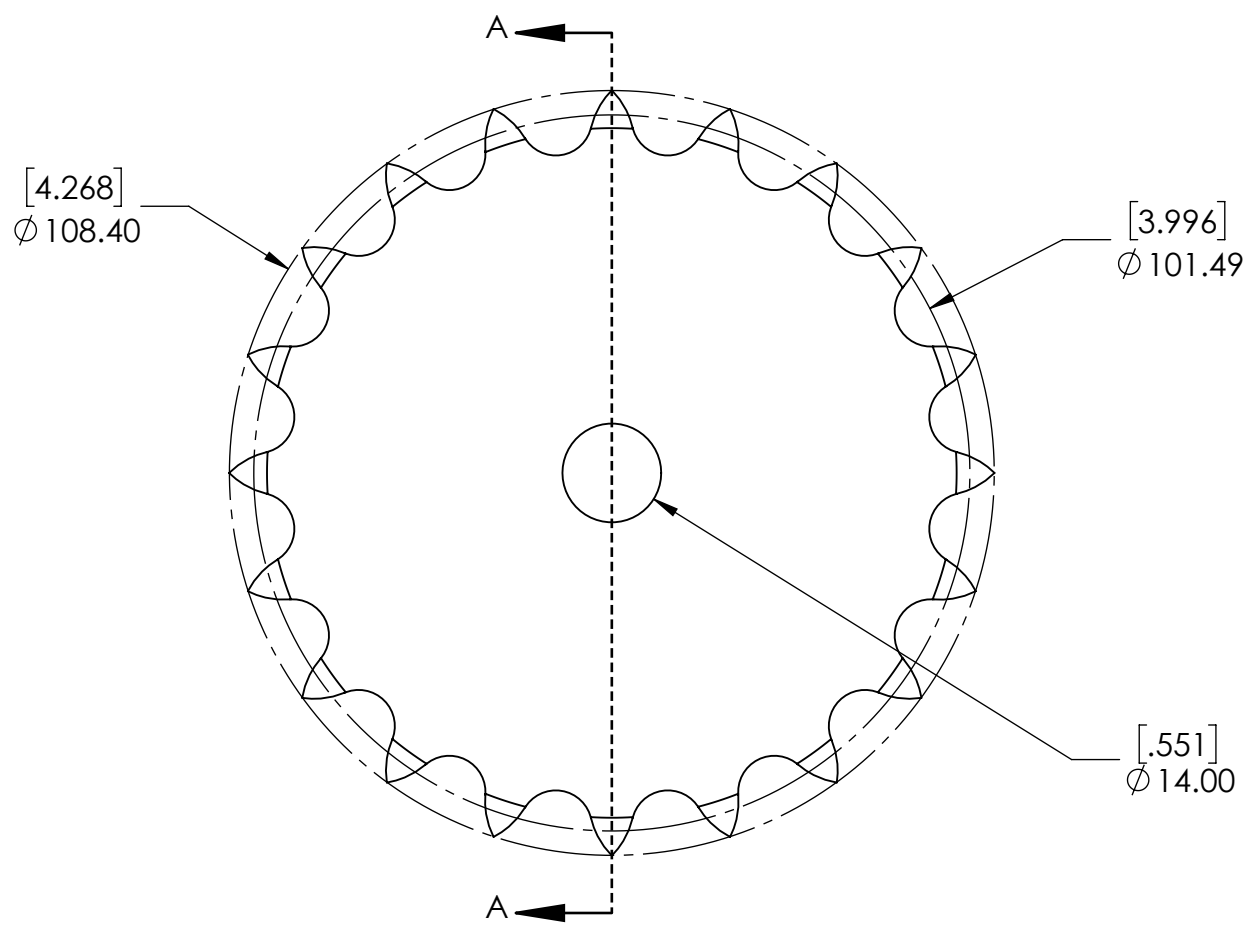

SECTION A-A

SPROCKETS SPECIFICATIONS		WEIGHT		DATE		BY		REVISION DESCRIPTION		REV
UNITS	mm (INCH)	2.68 LBS								
CHAIN SIZE	10B	MATERIAL	STEEL							
PITCH	15.88 mm	COATING	BLACK OXIDE							
INNER WIDTH	9.65 mm	DRAWN	SEC	07/21/2025						
ROLLER DIA.	10.16 mm	CHECKED	EG	07/21/2025						
TOOTH WIDTH	9.10 mm	APPROVED								
NUMBER OF TEETH	20									
HUB STYLE	B									
BORE TYPE	PLAIN BORE									
BUSHING NUMBER	N/A									
		DWG. NO.								
		<small>PROPRIETARY AND CONFIDENTIAL</small> <small>THE INFORMATION CONTAINED IN THIS DRAWING IS THE SOLE PROPERTY OF SOLVE IMG. ANY REPRODUCTION IN PART OR AS A WHOLE WITHOUT THE WRITTEN PERMISSION OF SOLVE IMG IS PROHIBITED.</small>								
								ITEM DESCRIPTION:		SCALE
								10B-20B		1:1
										REV
										-

9 8 7 6 5 4 3 2 1