

9 8 7 6 5 4 3 2 1

G
F
E
D
C
B
A

G
F
E
D
C
B
A

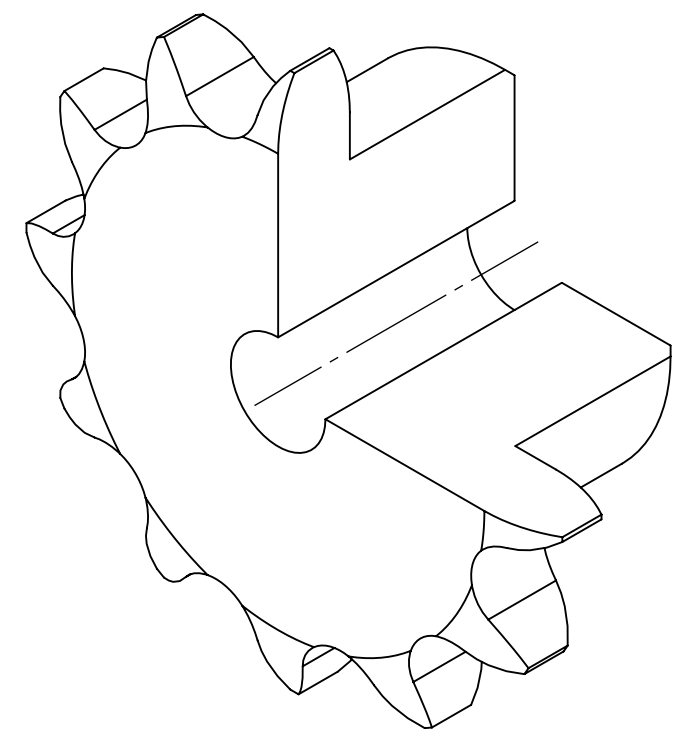
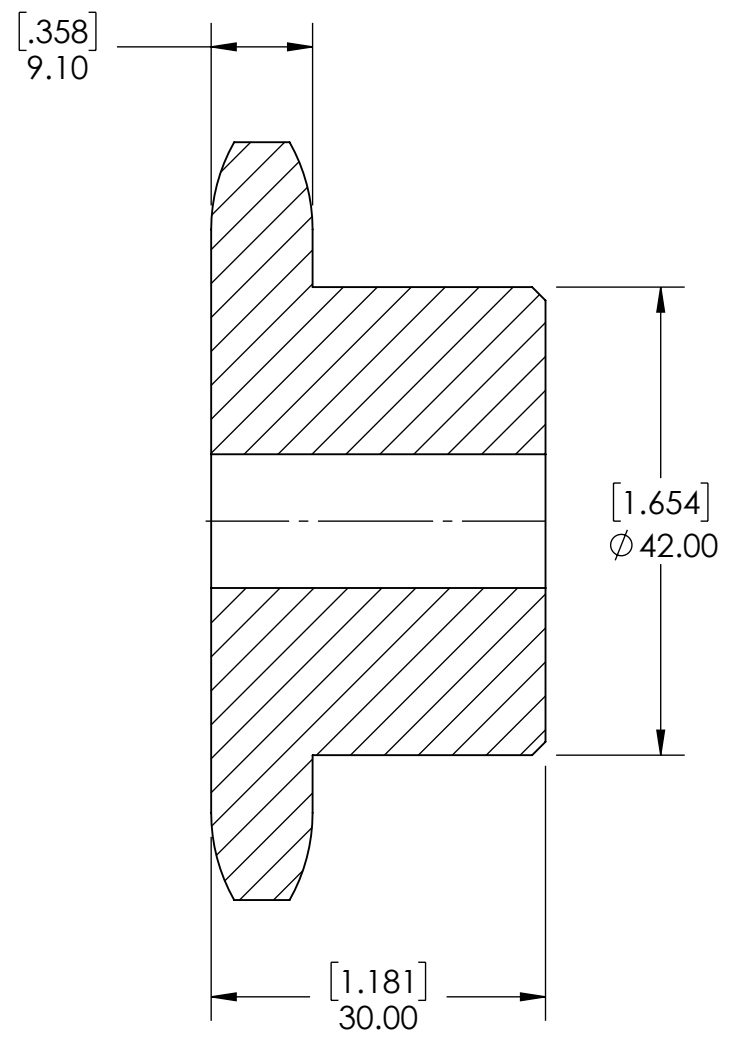
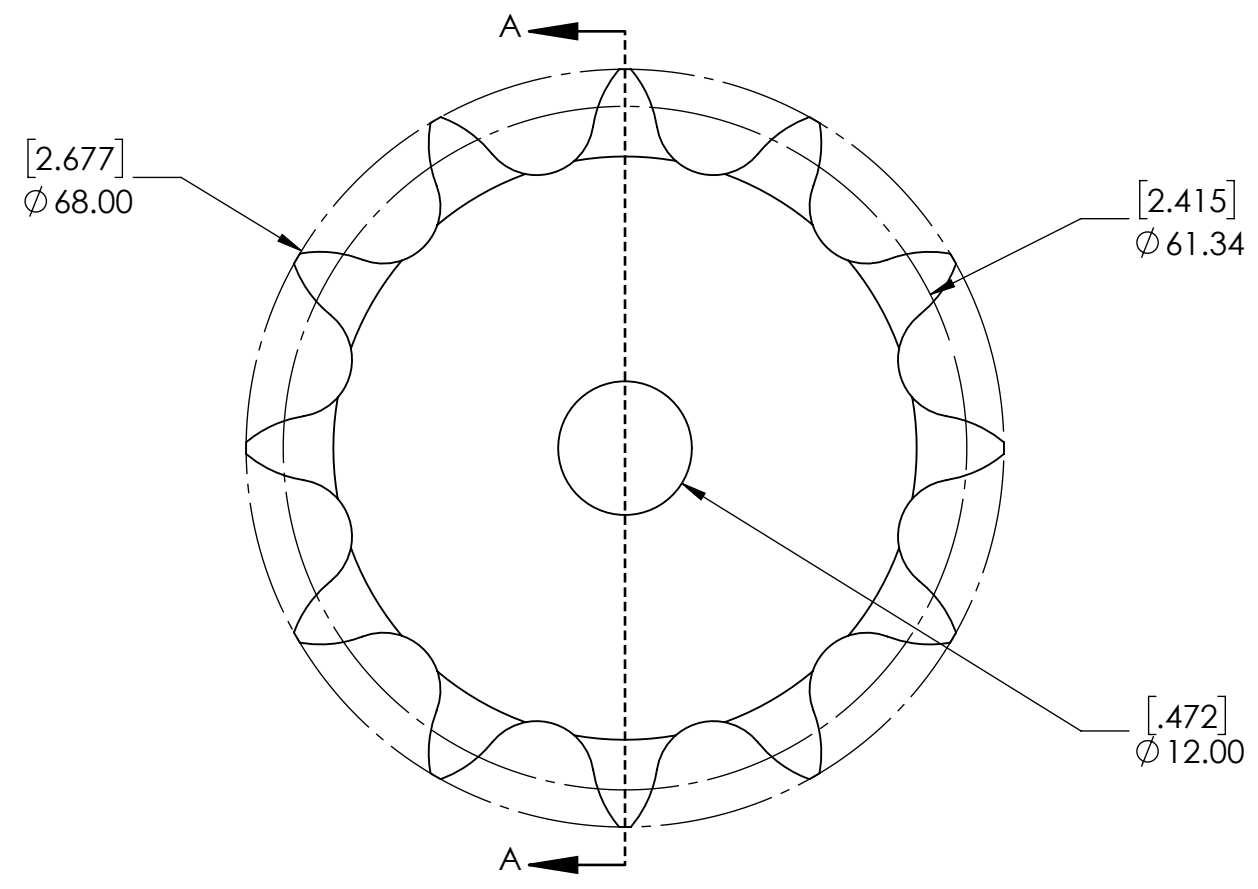

SECTION A-A

SPROCKETS SPECIFICATIONS		WEIGHT		0.86 LBS	
UNITS	mm (INCH)	MATERIAL	STAINLESS STEEL		
CHAIN SIZE	10B	COATING	N/A		
PITCH	15.88 mm	DRAWN	SEC	07/21/2025	
INNER WIDTH	9.65 mm	CHECKED	EG	07/21/2025	
ROLLER DIA.	10.16 mm	APPROVED	DATE BY REVISION DESCRIPTION		
TOOTH WIDTH	9.10 mm		ITEM DESCRIPTION:		
NUMBER OF TEETH	12		10B-12BSS		
HUB STYLE	B	DWG. NO.			SCALE
BORE TYPE	PLAIN BORE	PROPRIETARY AND CONFIDENTIAL			1:1
BUSHING NUMBER	N/A	THE INFORMATION CONTAINED IN THIS DRAWING IS THE SOLE PROPERTY OF SOLVE IMG. ANY REPRODUCTION IN PART OR AS A WHOLE WITHOUT THE WRITTEN PERMISSION OF SOLVE IMG IS PROHIBITED.			REV
					-

9 8 7 6 5 4 3 2 1