

9 8 7 6 5 4 3 2 1

G
F
E
D
C
B
A

G
F
E
D
C
B
A

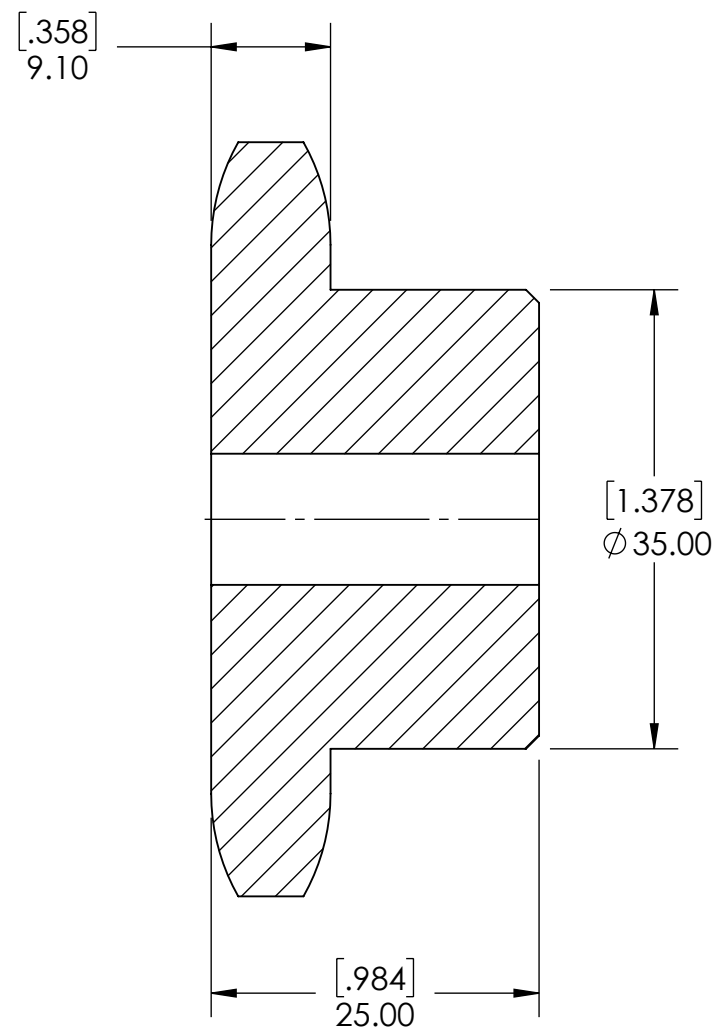
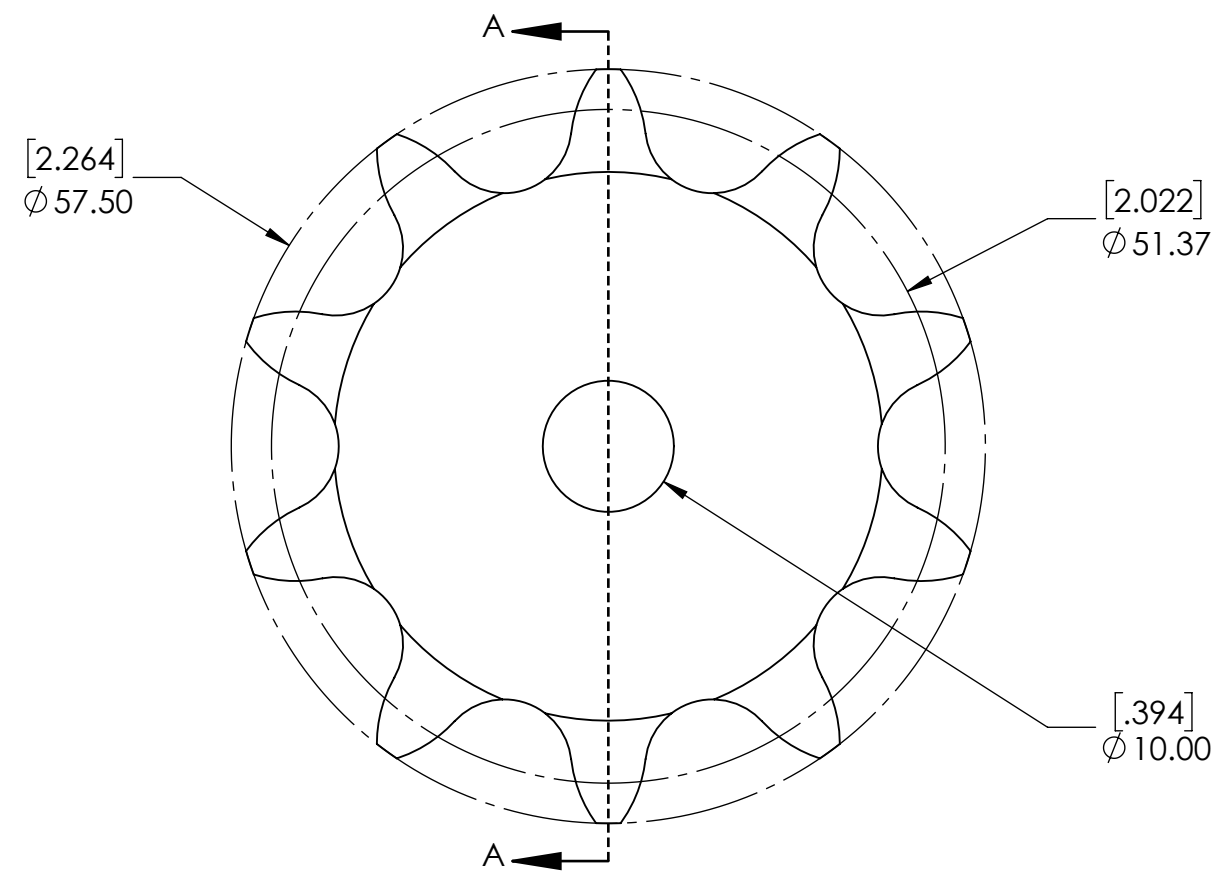

SECTION A-A

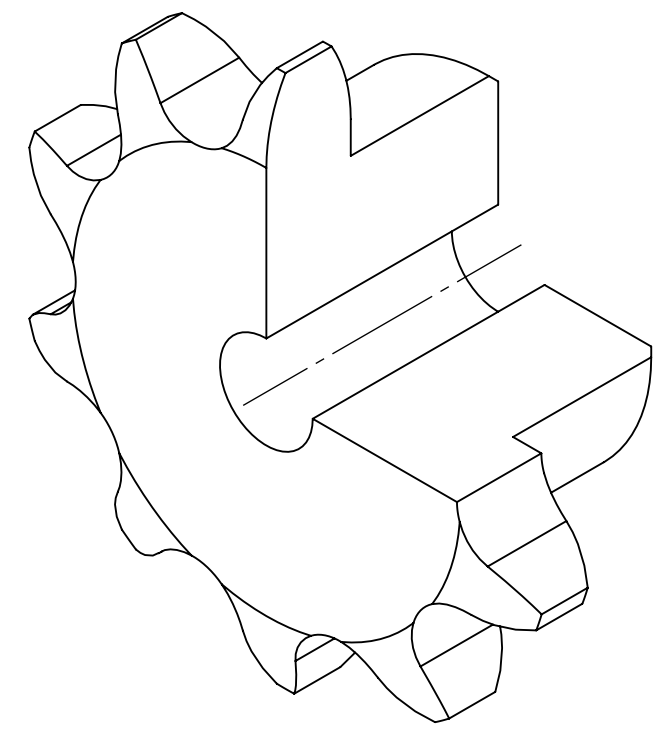

SPROCKETS SPECIFICATIONS		WEIGHT		0.50 LBS	
UNITS	mm (INCH)	MATERIAL	STEEL		
CHAIN SIZE	10B	COATING	BLACK OXIDE		
PITCH	15.88 mm	DRAWN	SEC	07/21/2025	
INNER WIDTH	9.65 mm	CHECKED	EG	07/21/2025	
ROLLER DIA.	10.16 mm	APPROVED			
TOOTH WIDTH	9.10 mm	DATE	BY	REVISION DESCRIPTION	
NUMBER OF TEETH	10	ITEM DESCRIPTION:			REV
HUB STYLE	B	10B-10B			1:1
BORE TYPE	PLAIN BORE				-
BUSHING NUMBER	N/A				



PROPRIETARY AND CONFIDENTIAL
THE INFORMATION CONTAINED IN THIS DRAWING IS THE SOLE PROPERTY OF SOLVE IMG. ANY REPRODUCTION IN PART OR AS A WHOLE WITHOUT THE WRITTEN PERMISSION OF SOLVE IMG IS PROHIBITED.

9 8 7 6 5 4 3 2 1