

9 8 7 6 5 4 3 2 1

G
F
E
D
C
B
A

G
F
E
D
C
B
A

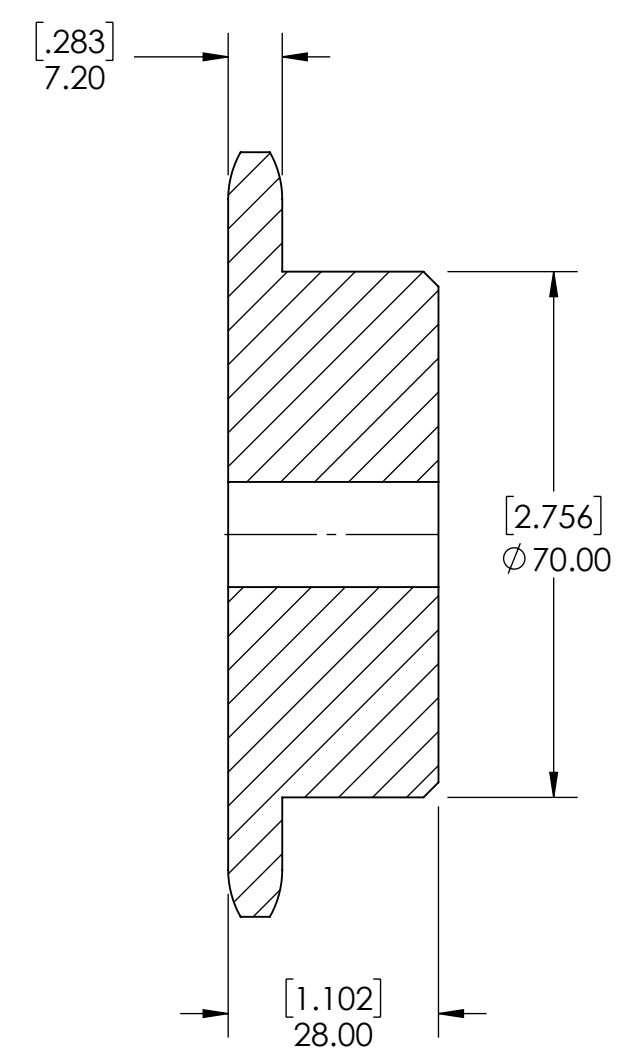
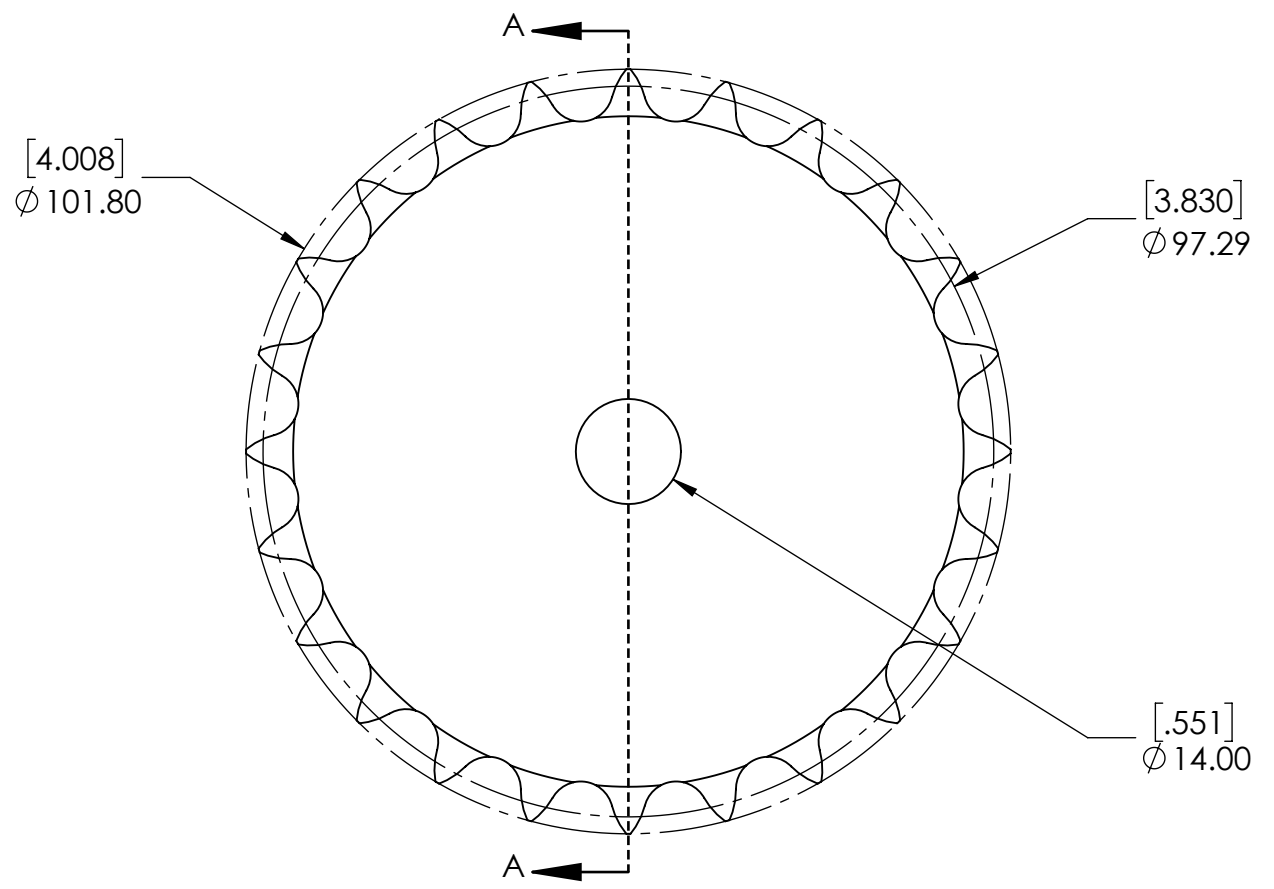

SECTION A-A

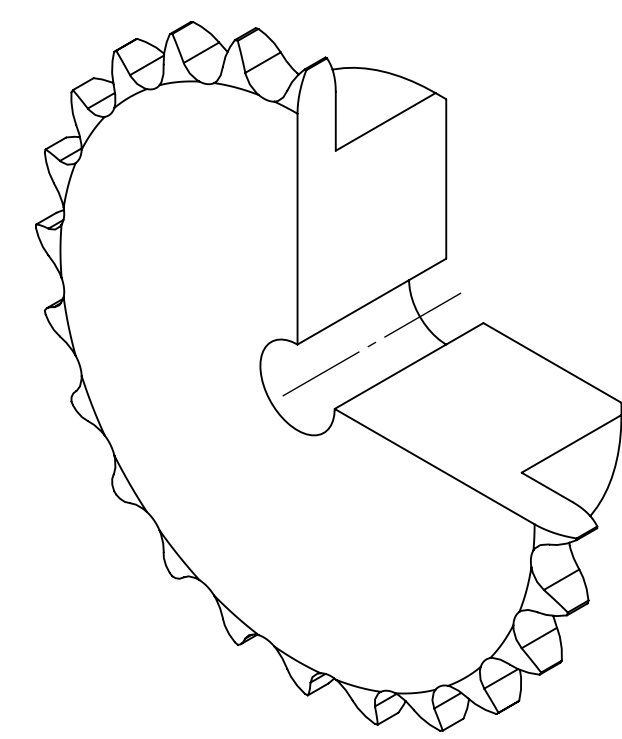

SPROCKETS SPECIFICATIONS		WEIGHT		DATE		BY		REVISION DESCRIPTION		REV
UNITS	mm (INCH)	2.15 LBS								
CHAIN SIZE	08B	STEEL								
PITCH	12.70 mm	BLACK OXIDE		07/21/2025						
INNER WIDTH	7.75 mm	DRAWN		SEC						
ROLLER DIA.	8.51 mm	CHECKED		PT						
TOOTH WIDTH	7.20 mm	APPROVED								
NUMBER OF TEETH	24	THIRD ANGLE PROJECTION								
HUB STYLE	B	DWG. NO.								
BORE TYPE	PLAIN BORE	PTI		PROPRIETARY AND CONFIDENTIAL						
BUSHING NUMBER	N/A	ITEM DESCRIPTION:		08B-24B						
										SCALE
										1:1
										REV
										-

9 8 7 6 5 4 3 2 1